

Dometic

Dometic AES REFRIGERATOR DIAGNOSTIC SERVICE MANUAL

The Dometic Corporation

Corporate Office 2320 Industrial Parkway
Elkhart, In. 46515
219-295-5228

Warranty **205 E. Fenn St.**
Department **LaGrange, In. 46761**
219-463-2191

Technical Services 509 S. Poplar St.
Department LaGrange, In. 46761
219-463-4858

TABLE OF CONTENTS

Diagnostic Flow Charts	
No Operation	A-5- 1
No 120V AC Operation	A-5-2
No 12V DC Operation	A-5-3
No Gas Operation.	A-5-4
Operation and Diagnosis	
Dometic AES Refrigerators	A-6- 1
Glossary of Terms	A-7- 1
Continuity Readings for Switch Card and Harness	A-8- 1
Service Bulletins.	A-9- 1
AES Refrigerator Manual Subscription Form	A-14



AES REFRIGERATOR DIAGNOSTIC FLOW CHART

NO OPERATION

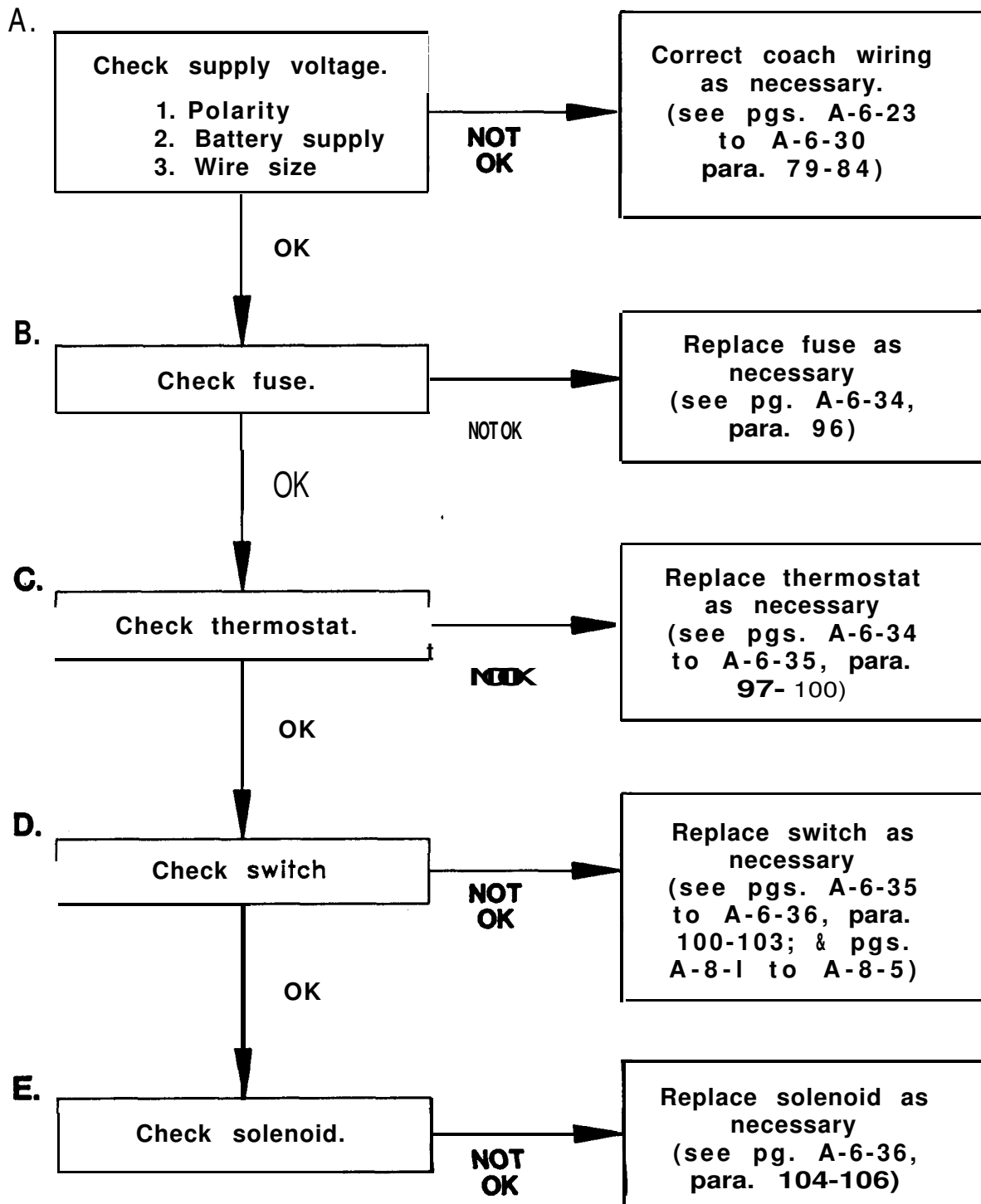

AES REFRIGERATOR

DIAGNOSTIC FLOW CHART

NO 120V AC Operation

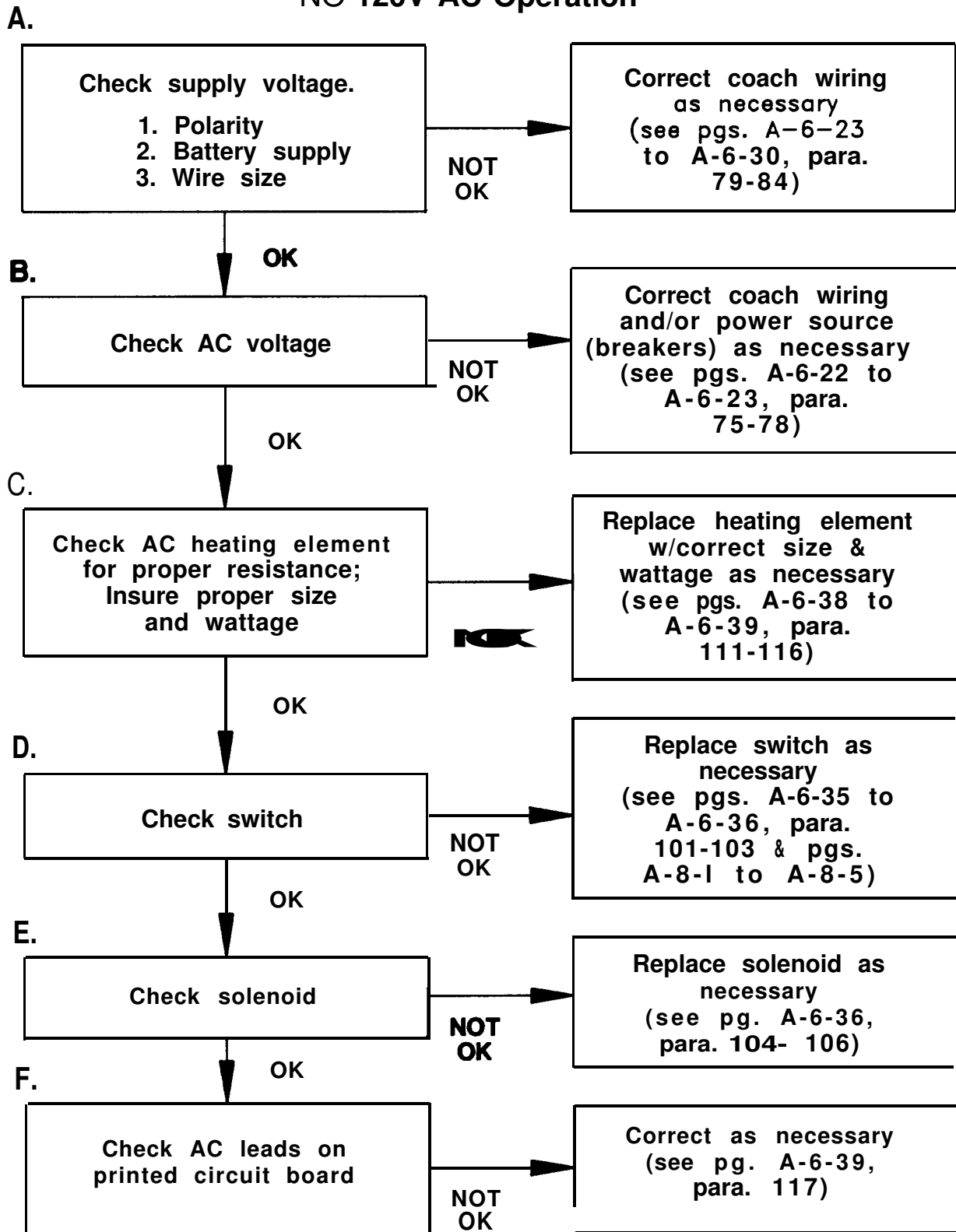

AES REFRIGERATOR DIAGNOSTIC FLOW CHART NO 12 VOLT DC OPERATION

A.

Check supply voltage
1. Polarity
2. Battery supply
3. Wire size

NOT
OK

Correct coach wiring as necessary
(see pgs. A-6-23 to A-6-30,
para. 79-84)



OK

B.

Check that refrigerator
is wired directly to
12V battery

NOT
OK

Correct wiring as necessary
(see pgs. A-6-27 & A-6-29)



OK

C.

Check for proper gauge
wire in 12V installation

NOT
OK

Rewire w/proper gauge wire as
necessary (see chart on pg. A-6-26)



OK

D.

Check ignition lock
terminal for 12V when
ignition key is placed
in the "ON" position only

NOT
OK

Repair circuit as necessary
(see pg. A-6-40,
para. 120)



OK

E.

Check DC relay

NOT
OK

Replace relay as necessary
(see pgs. A-6-41 to
A-6-42, para. 123-l 27)



OK

F.

Check 12V DC element

NOT
OK

Replace element as necessary
(see pgs. A-6-42 to
A-6-43, para. 128-l 29)



OK

G.

Check switch

NOT
OK

Replace switch as necessary
(see pgs. A-6-35 to A-6-36, para.
101-103 8c pgs. A-8-1 to
A-8-5)



OK

H.

Check printed circuit
board & connections

NOT
OK

Correct connections and/or
replace printed circuit
board as necessary (see pgs.
A-11-3 to A-11-5)

AES REFRIGERATOR

DIAGNOSTIC FLOW CHART

NO GAS OPERATION

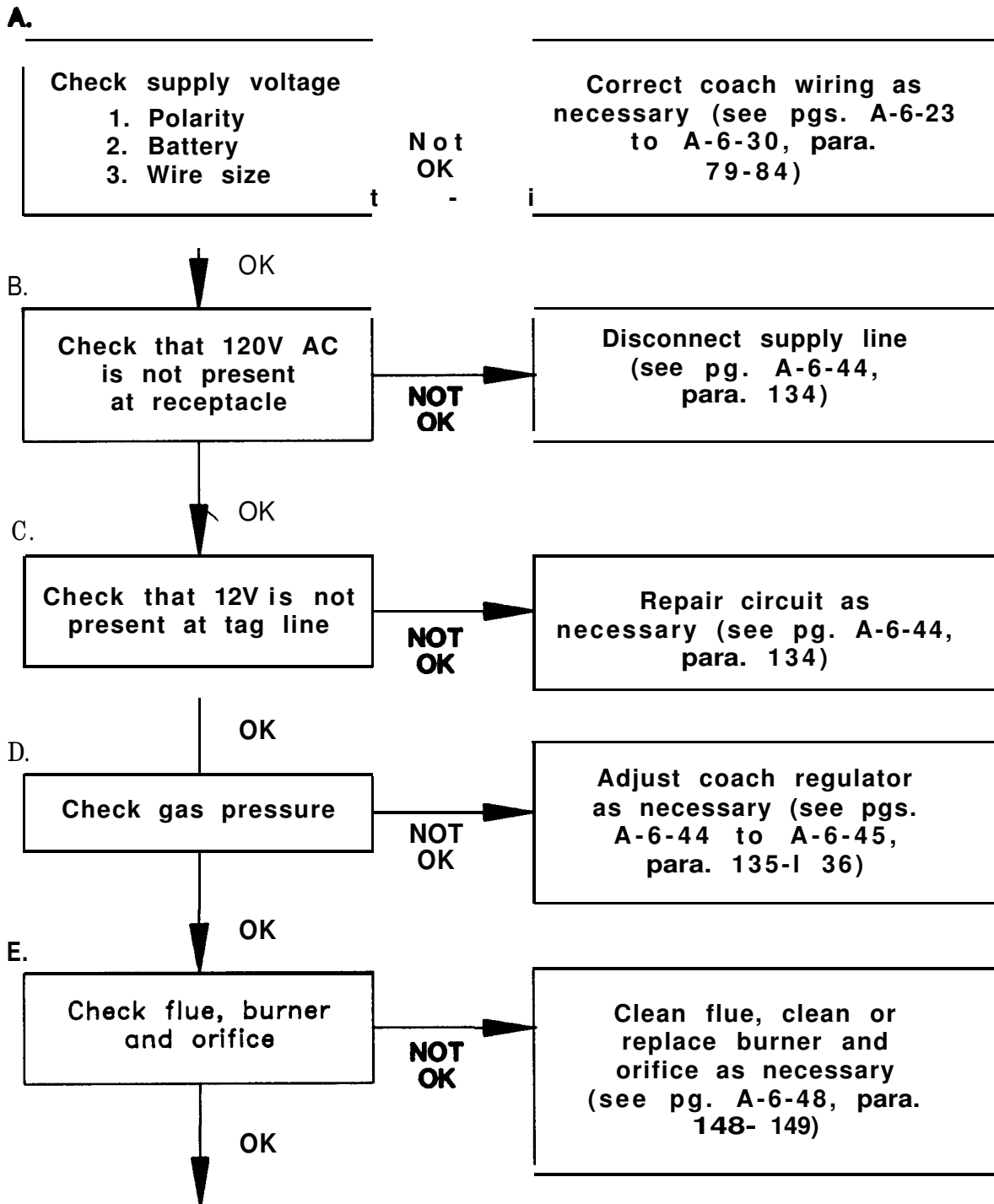

(continued on page A-5-5)

AES REFRIGERATOR
DIAGNOSTIC FLOW CHART
NO GAS OPERATION (continued)

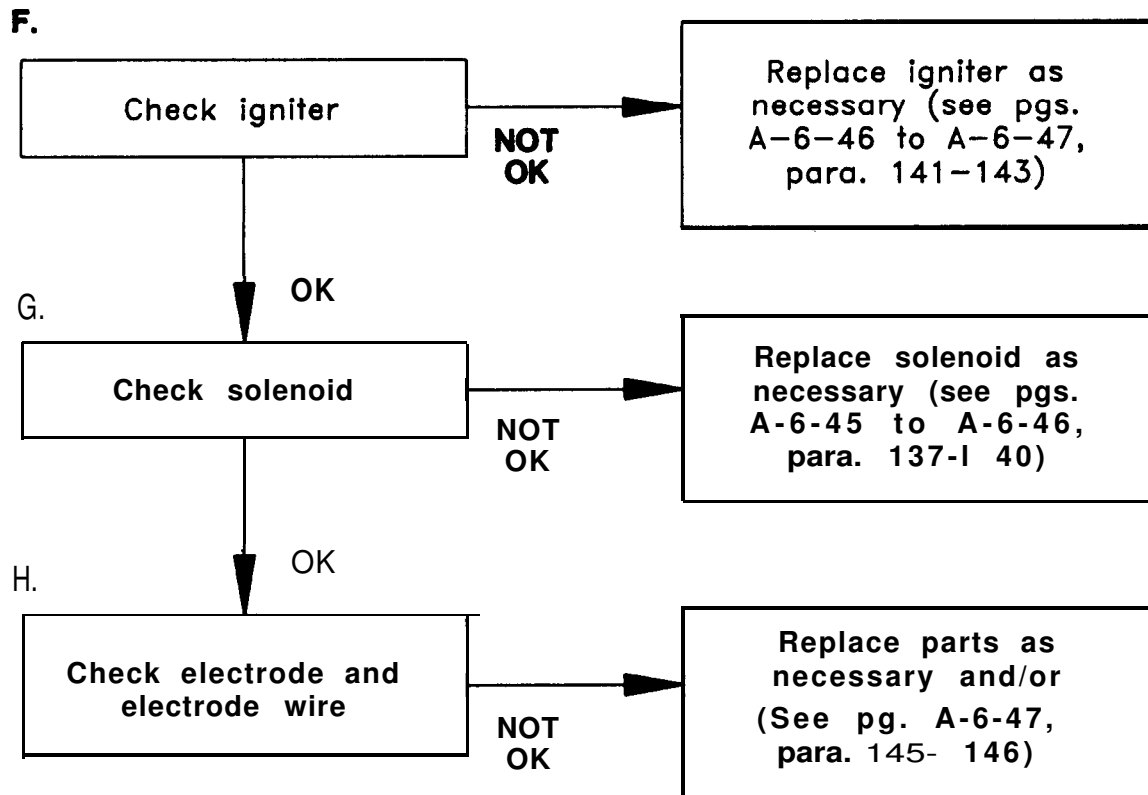

**OPERATION AND DIAGNOSIS
DOMETIC AES REFRIGERATORS**

(1)

Welcome to the Dometic A.E.S. refrigerator training program. In this program we will discuss the features, operating sequences and diagnostic procedures for the Dometic refrigerators that are equipped with the Automatic Energy Selector Control system; A.E.S. for short.

(2)

With this type of control system the customer no longer has to manually switch the refrigerator to the desired mode of operation. All that is left for the customer to do is to turn the refrigerator "ON" and to select the desired temperature range by way of the thermostat knob. The refrigerator will automatically select between 120V AC, 12V DC or LP gas to operate the refrigerator.

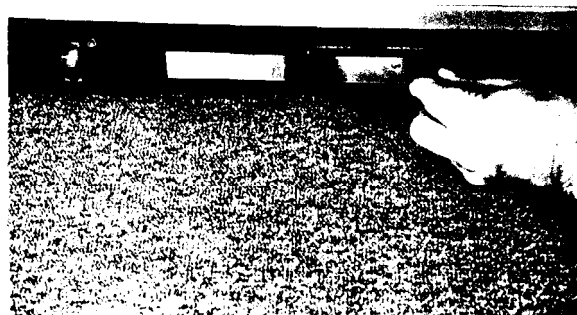

(3)

The selection will be made electronically with the highest priority going to the 120V AC cooling mode; second priority going to the 12V DC heating element, providing the motor home's ignition key is turned "ON" and the vehicle is in motion. Last priority is LP gas operation.

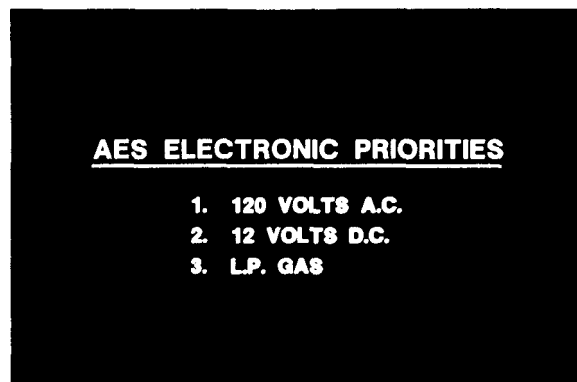

(4)

Since the introduction of the first A.E.S. refrigerators in 1983 there have been three distinct model series or "generations" available. We will discuss each of the three model generations separately to illustrate the parts location and operational differences between each model series.



(5)

Shown here is the RM1303 that is one of the models that make up the first generation A.E.S. refrigerators. The models in this series include from the smallest size to the largest size: the RM663 which is a 5 cubic foot refrigerator, the RM763 which is a 6 cubic foot refrigerator and lastly, the RM1303 which is an 8 cubic foot refrigerator.



(6)

Let's now take a closer look at the parts location and operation of these models. From the lower front of the refrigerator we can see the main control panel assembly. This assembly contains the two control knobs and the L.E.D. lamp that will illuminate when the refrigerator is turned on.

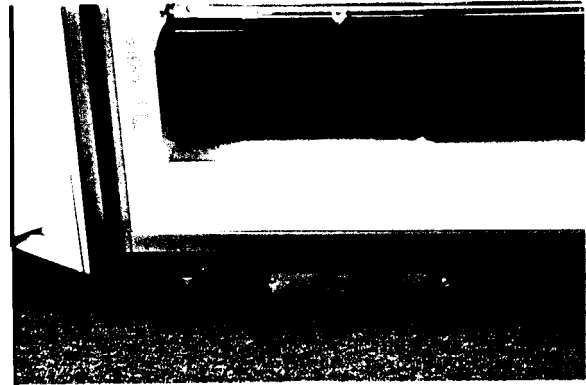

(7)

The knob on the right is the main switch that is used to turn on the refrigerator and the knob to the left is the thermostat control that is used to regulate the lower cabinet temperatures within the food zone range.



(8)

When the unit is turned on, the L.E.D. lamp will illuminate green to let the customer know that the refrigerator is turned on and that the system has sufficient DC voltage to operate the refrigerator.

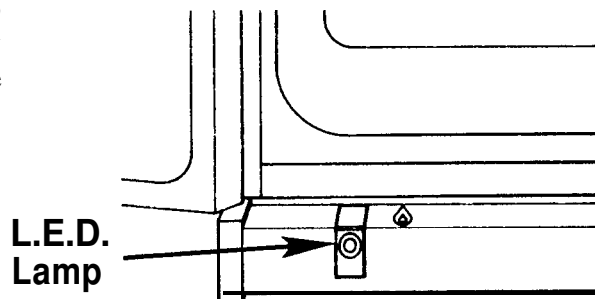

(9)

It must be remembered that a DC wire hook-up to the terminal block is required for any A.E.S. refrigerator to operate on 120 volts AC, 12 volts DC or LP gas.

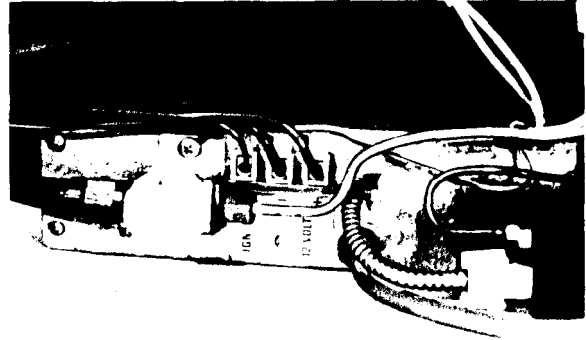

(10)

From the rear of our example we can see the shut-off valve and knob where the main LP gas supply is connected to the refrigerator, 12 volt DC terminal block where the 12 volt power source comes into the refrigerator to operate the system and the LP gas solenoid valve which includes the 12 millimeter test plug where the LP gas pressure can be checked.



(11)

The solenoid valve replaces the user operated flame failure safety device that is found on the manually controlled refrigerator models.

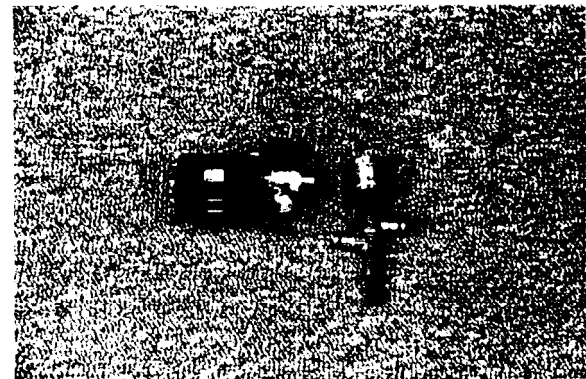

(12)

Finally, to the right of the solenoid valve is the orifice burner assembly which generates the heat required on the LP gas mode to operate the absorption cooling unit.

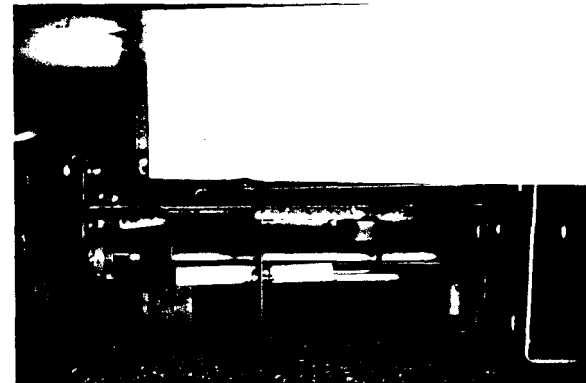

(13)

Just above the burner assembly, located in the generator section of the cooling unit, are the 12 volt DC and 120 volt AC heating elements that provide the heat to the cooling unit on those modes.



(14)

By removing the two screws on the left side of the base assembly and one screw in the burner area, rotate the clamping plate clockwise to remove it.

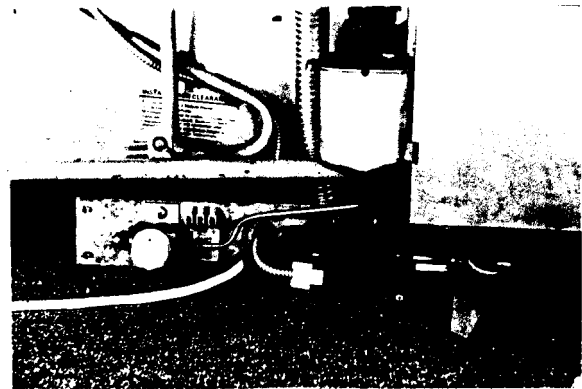

(15)

The mounting plate assembly can then be moved backward to gain access to the remaining parts in the control system.

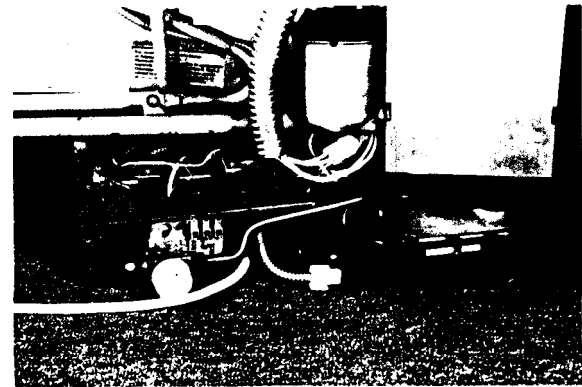

(16)

From this view we can see the Printed Circuit Board which controls the automatic heat selection functions of the refrigerator and the 12 volt DC relay which energizes the 12 volt DC heating element when the automatic selection calls for 12 volt operation. To the right of the DC relay is the igniter reigniter module.

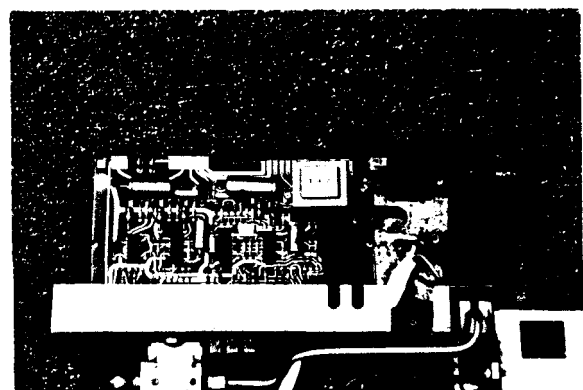

(17)

This component replaces the piezo lighter that has been used on Dometic manually controlled refrigerators for several years. When the automatic controls select LP gas operation, 12 volts are sent to the igniter which produce a high voltage to create a pulsating spark at the burner. If for any reason the flame blows out, the igniter will re-light the flame at the burner.

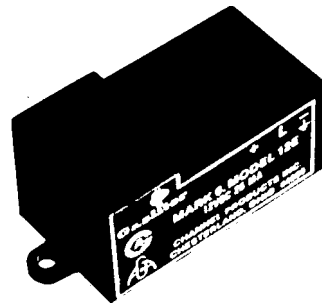

(18)

To better understand how the first generation series models operate, we will illustrate how a typical RV family would use the refrigerator. It is always recommended to pre-cool the refrigerator before taking the RV on a trip to gain the most efficiency from the unit. So, a day or two before the customer plans to leave on vacation the coach is plugged into 120 volts shore power.



(19)

The customer then selects the desired thermostat setting on the refrigerator. A normal setting for the first generation series is setting number 4, which will provide an approximate lower cabinet temperature range of 35 to 40 degrees.

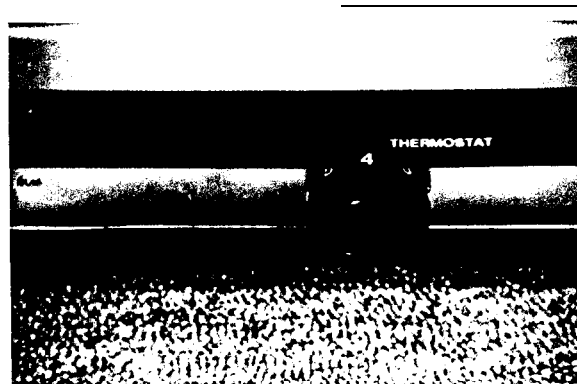

(20)

Now, when the main rotary switch is turned on, the refrigerator will automatically start operating on the 120 volt AC cooling mode.

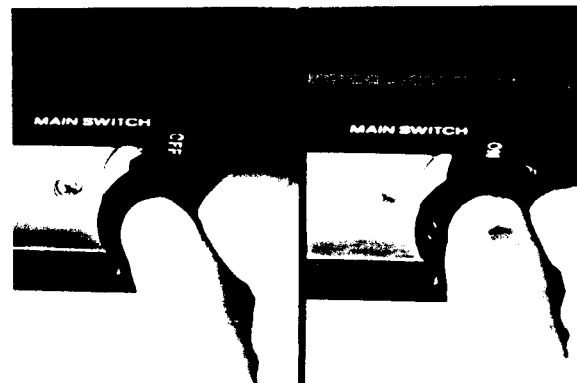

(21)

To let the customer know that the switch is properly turned on and that there is sufficient DC power to energize the system, L.E.D. lamp will illuminate green.

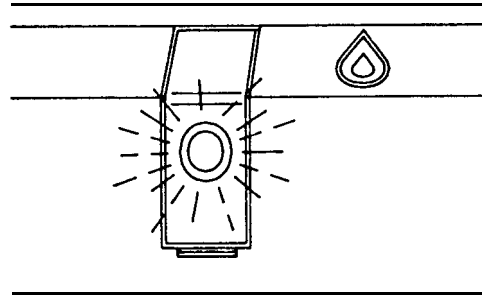

(22)

After the refrigerator has reached the desired cabinet temperatures, the customer then can load the refrigerator with pre-chilled food.

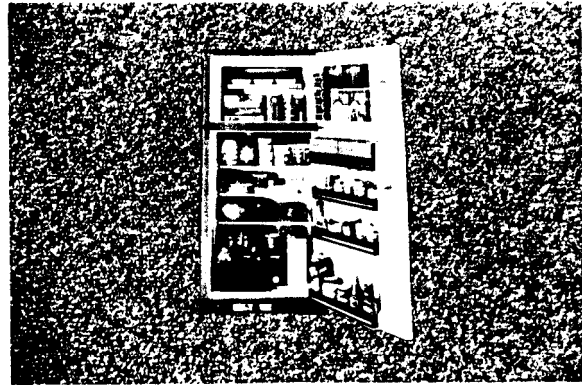

(23)

When the RV family is ready to begin travelling, coach's owner disconnects the shore line from the power source, which will discontinue the operation of the 120 volt heating element.



(24)

At this time the refrigerator's controls will automatically light the burner assembly and the unit will be fully functional on the LP gas mode. This automatic mode selection is accomplished without the need to manually reset the refrigerator. What could be easier?

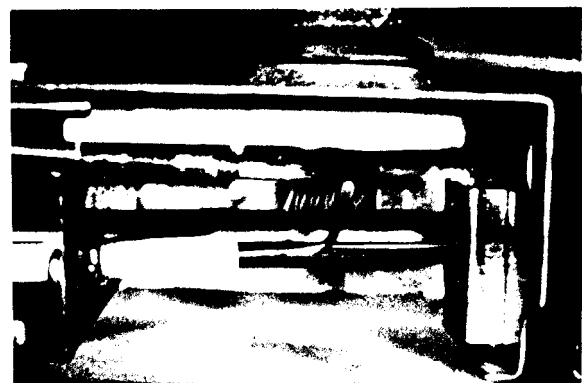

(25)

When the driver gets in the vehicle and turns on the ignition key, the gas flame will shut off and the 12 volt heating element will be energized to operate the refrigerator while traveling.



(26)

This automatic switching to the 12 volt DC heating element mode is accomplished by the correct field wiring of the ignition lock terminal on the rear of the refrigerator, which we will discuss in further detail later in the program.

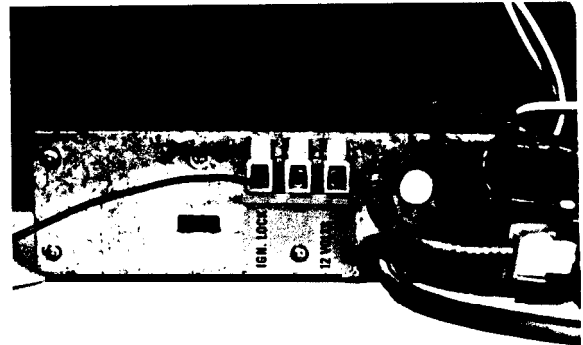

(27)

When the vehicle's ignition switch is turned off when stopping to refuel, there is no need to manually turn off the refrigerator to prevent the gas flame from lighting. Incorporated into the electronic controls is a safety delay. This will prevent the burner from lighting for approximately 25 minutes after the ignition key is turned off.



(28)

After this delay time and the ignition key has not been turned on or 120 volts has not been supplied, the refrigerator will then re-light on LP gas.

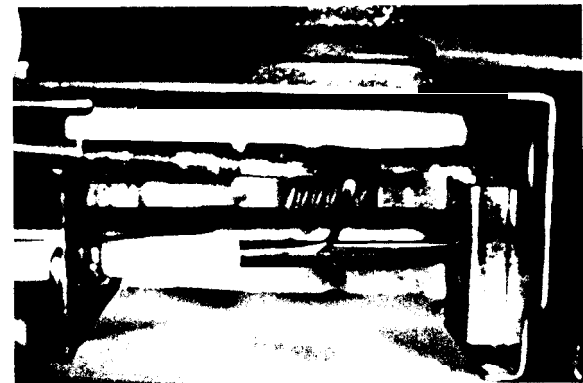

(29)

NOTE: The 120 volt mode is not affected by the delay cycle. Any time the refrigerator is supplied with 120 volts AC the unit will be fully operational on the AC mode, even if the refrigerator is in a delay cycle.

THE 120 VOLT MODE IS NOT AFFECTED BY THE DELAY CYCLE

(30)

After the customers have reached the campsite and have parked the RV, they plug the 120 volt shore line into a power source. At this point the unit will operate it's ingrained priority system.



(31)

The added benefit of this system is if the AC power source is lost during a storm or the like, the refrigerator will automatically switch to the LP gas mode during the power failure. As soon as the AC power is re-established, the A.E.S. system will switch again to 120 volts.

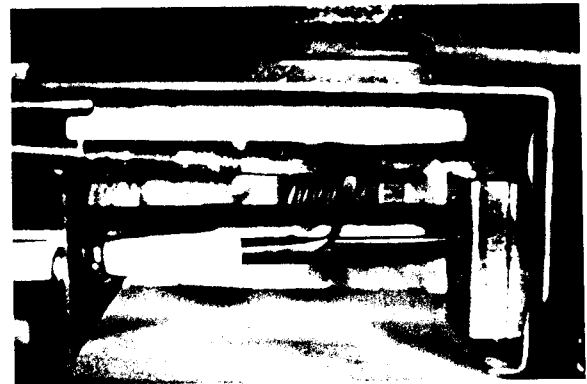

(32)

Now that we have a basic understanding of how a customer will use an A.E.S. refrigerator, let's take a look at some of the other features incorporated into the control system. First, we have the L.E.D. lamp assembly which will provide the customer with useful information in regard to the operation of the refrigerator.

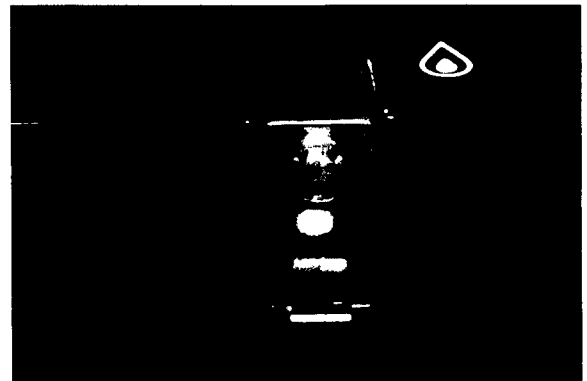

(33)

As we stated earlier, in normal operation the L.E.D. lamp will illuminate green.

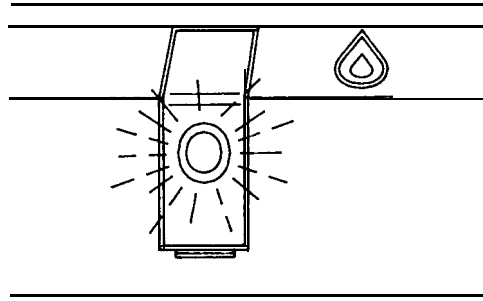

(34)

On the LP gas mode, if a proper gas flame is not established within approximately 3 minutes, the lighting sequence will shut off and the L.E.D. will begin flashing red to warn the customer that the refrigerator has failed to light on LP gas. This does not always indicate that the refrigerator is broken. It is simply a warning device to let the customer know that the refrigerator did not light due to a lack of LP gas, that the burner is dirty or there is air in the LP supply lines.

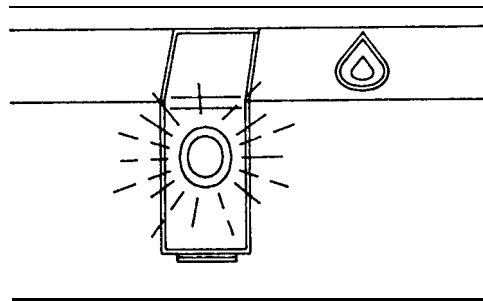

(35)

To reset the lighting sequence; turn the main switch to the off position, wait approximately 5 seconds, then turn it back on. This will reset the controls to provide another approximate 3 minute lighting period as well as to reset the L.E.D. lamp to green. If, repeated attempts to light the system fail, troubleshooting the LP gas system is in order, which we will discuss in the troubleshooting segment of the program.

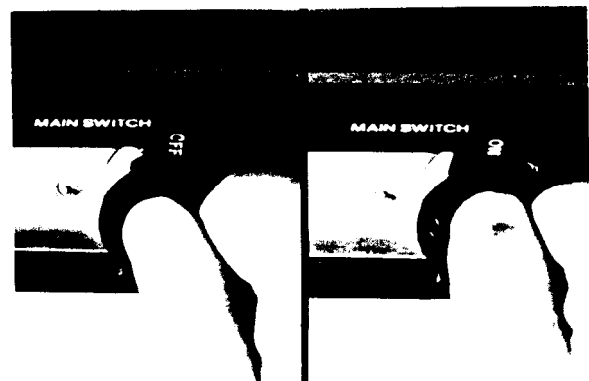

(36)

Second, the control system incorporates a low battery protection circuitry that will prevent a total lack of cooling due to a gradual loss of 12 volts DC to the refrigerator's terminal block. If the battery voltage to the terminal block drops to approximately 9.5 volts DC and the refrigerator is operating on 120 volts or LP gas, the system will electronically bypass the thermostat and the refrigerator will operate continuously on LP gas until the low voltage condition is corrected.

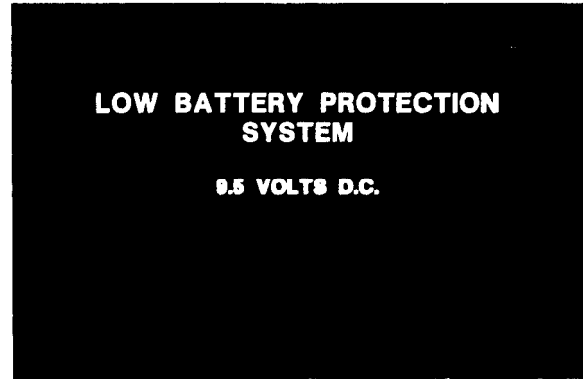

(37)

As a warning of this condition the L.E.D. lamp assembly will shut off during the voltage drop. When the battery voltage returns to an acceptable level the green L.E.D. lamp will turn on and the refrigerator will again operate on its predetermined priority system.

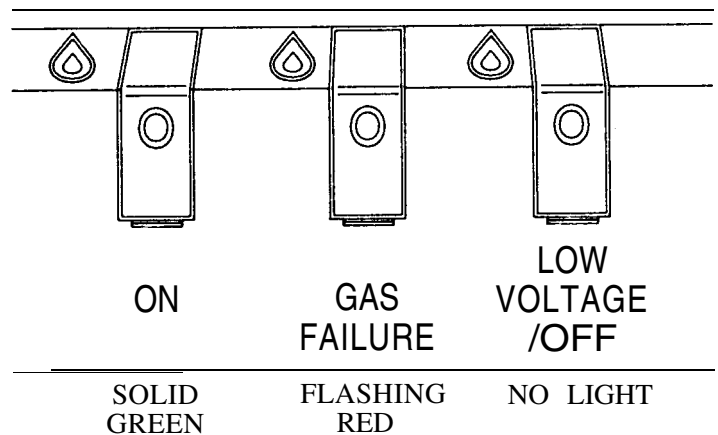

(38)

On the 12 volt heating element mode, the DC relay will interrupt the 12 volt circuit to the heating element if the battery voltage becomes low. NOTE: During this low voltage, the LP gas flame will not be lit.

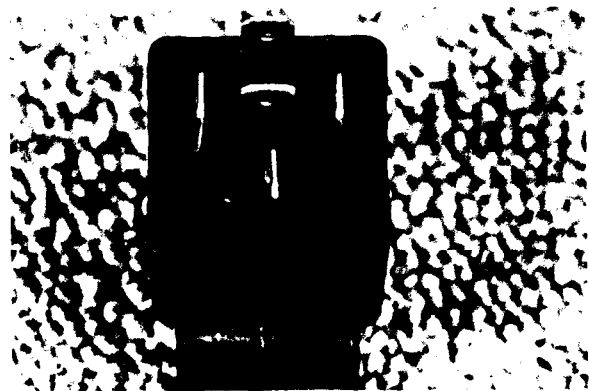

(39)

The last feature that we need to discuss is the operation of the thermostat on the LP gas mode. Unlike the manually controlled models, A.E.S. refrigerators do not have a high and low flame to regulate the interior cabinet temperatures. The high flame, that is present after the lighting sequence, will shut off completely when the thermostat reaches the preset temperature. The automatic controls will then relight the burner when the thermostat calls for cooling. This allows the refrigerator to utilize the LP gas mode in a much more efficient manner, very similar to the pilot-less gas stoves that are now becoming quite popular.

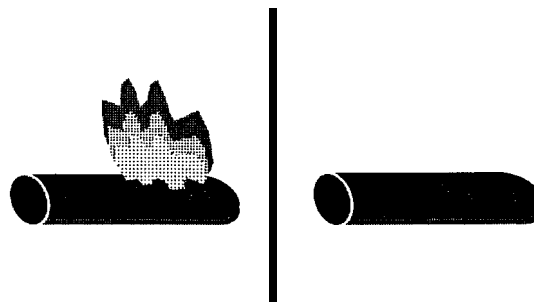

(40)

The models that make up the second generation series A.E.S. refrigerators include: the RM3500, RM3600 and RM3800. The RM 3500 being a 5 cubic foot refrigerator, the RM3600 being a 6 cubic foot model and the RM 3800 being an 8 cubic foot refrigerator. The function and operation of this model series is the same as the first generation. The main difference with the second generation model series is of parts relocation and decoration refinements. Let's take a look at these design differences.



(41)

From the upper front decoration we can see that the switch L.E.D. lamp assembly is located on the upper front exterior of the refrigerator, making it easier to turn on and off. The switch in this format uses a slider versus the rotary version found on the first generation models.

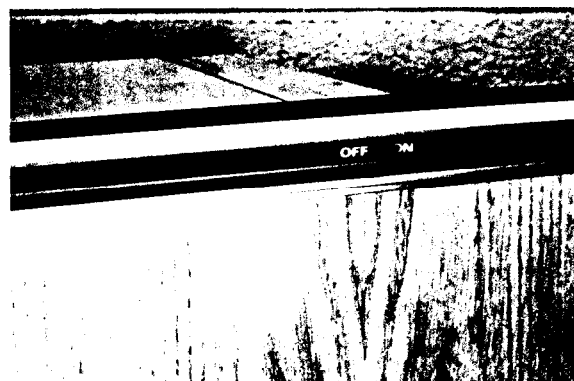

(42)

The L.E.D. lamp assembly contains two separate diodes, one green and one red that are an integral part of the switch.

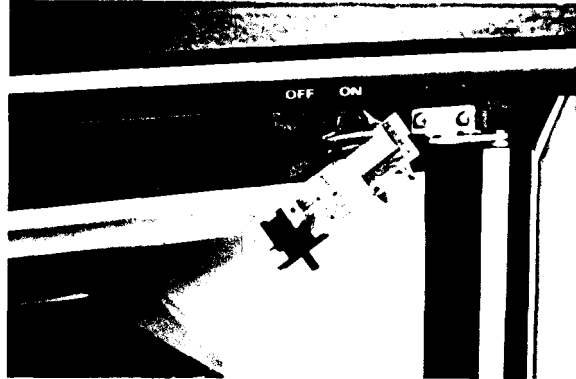

(43)

From the interior of the refrigerator we can see the **thermostat-interior lamp assembly**, which is similar to the thermostat assembly found on many residential type refrigerators.

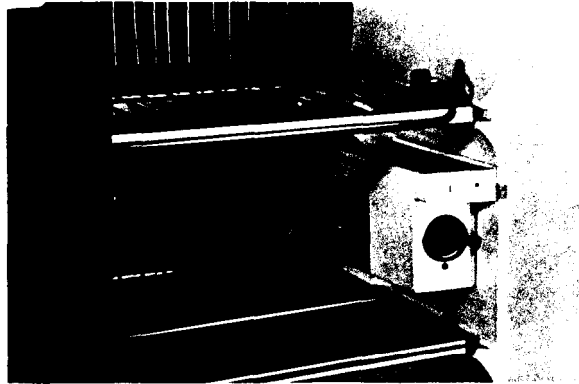

(44)

The thermostat knob does not have the numbered increments as found on the first generation models. The markings of 'MIN' and 'MAX' indicate the warmest and coolest settings that can be obtained with the assembly. As with previous thermostats, rotating the knob clockwise will decrease the lower cabinet temperature, while rotating it counterclockwise will increase the lower cabinet temperature.

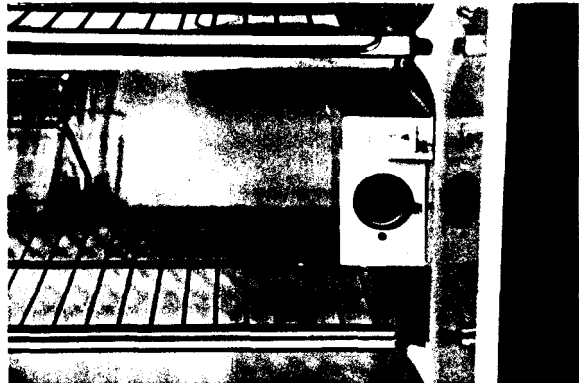

(45)

From the rear we can see that the component parts have been relocated directly on the rear of the refrigerator. This allows better serviceability and lets us incorporate a new thin-line base to provide the same cubic foot interior, but shortening exterior cut-out dimensions.

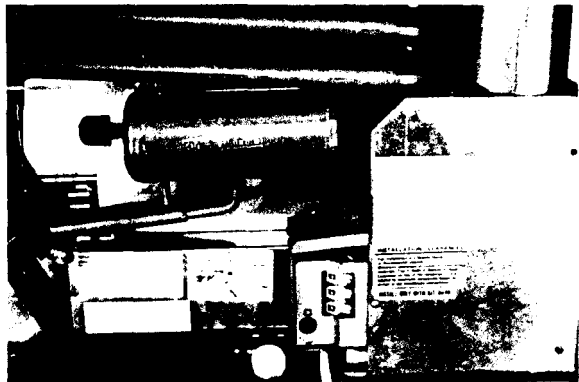

(46)

Here we see the cut-off valve and the printed circuit board and its connections.

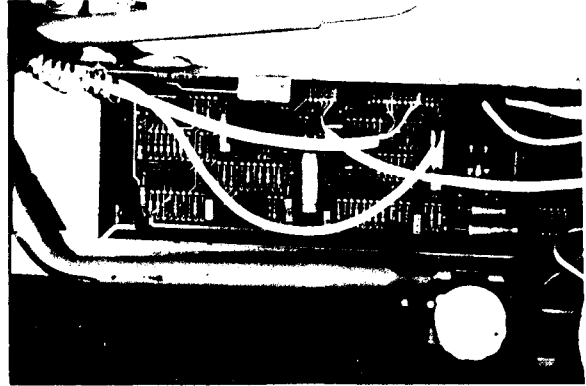

(47)

Next, we can view the igniter-reigniter, DC relay and just below these components is the LP gas solenoid valve. To the right of this is the orifice-burner assembly.

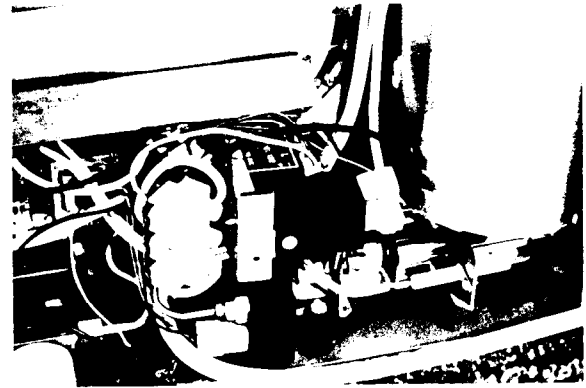

(48)

The third generation series models include: the **RM3601**, a 6 cubic foot refrigerator and the **RM3801**, an 8 cubic foot refrigerator. These two models incorporate the latest technology in A.E.S. refrigerators. They offer expanded functions and features that were not previously available on the first or second generation series models. The general construction and layout is very similar to the second generation models.



(49)

From the rear we can see that the cut-off valve, printed circuit board, igniter, relay, solenoid valve and burner assemblies are in similar locations as the second generation series.

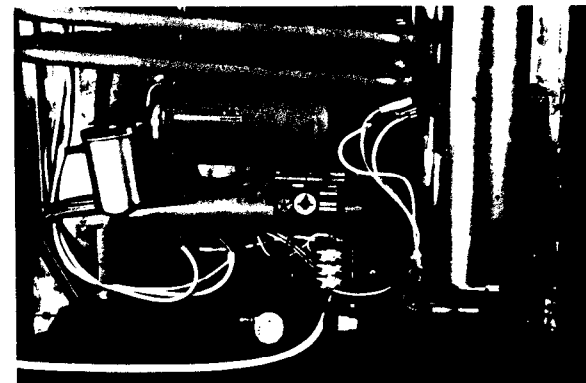

(50)

From the front there are two notable differences. The front upper decoration houses the mode switches as well as the L.E.D. lamp indicators that can give the customer useful information on what mode the refrigerator is operating on.

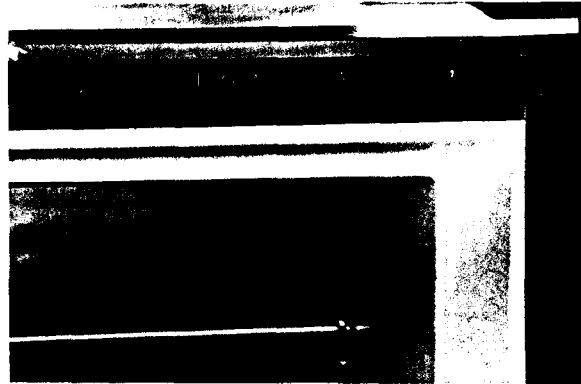

(51)

Inside the refrigerator is the **thermostat interior lamp assembly** that contains the redesigned thermostat knob.

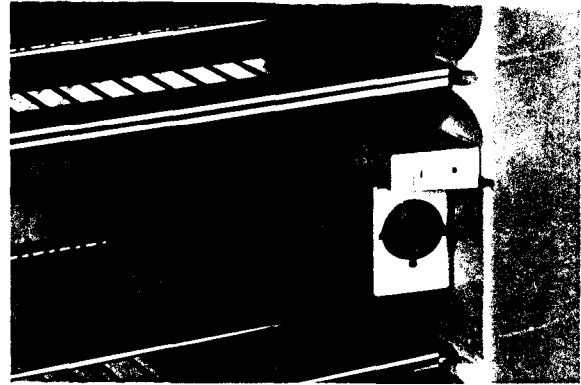

(52)

The knob is marked at the warmest setting with letters MIN, which is an abbreviation for minimum. The coldest setting is marked MAX, which stands for maximum. In the central portion of the knob is the normal temperature range that the customer would utilize in most situations. This portion of the knob is marked NORMAL. Let's take a few moments to discuss the third generation models in detail.

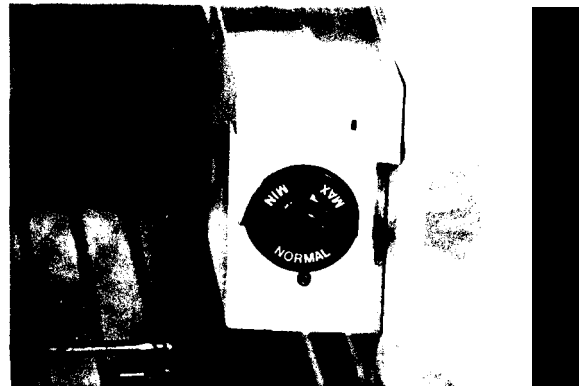

(53)

These refrigerators are equipped with a similar type of **automatic energy control system** that is found on both the first and second generation models. In the fully automatic mode the heat selection will be made electronically with the highest priority going to the 120 volt AC mode. The second priority will go to the 12 volt DC heating element when the vehicle's ignition switch has energized the ignition lock terminal. The last priority is the LP gas mode.

AES ELECTRONIC PRIORITIES

1. 120 VOLTS A.C.
2. 12 VOLTS D.C.
3. L.P. GAS

(54)

The customer can manually select the controls to operate on AC and LP gas only; again with AC having priority over the LP gas mode or the customer may select LP gas only.

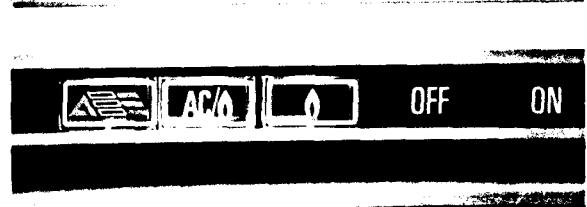

(55)

When the main switch is turned on the electronic control system will always select the fully automatic mode. At this time the A.E.S. pushbutton switch will illuminate green indicating the system has selected the fully automatic mode. As with the earlier A.E.S. models the refrigerator will select between 120 volts AC, 12 volts DC or LP gas.

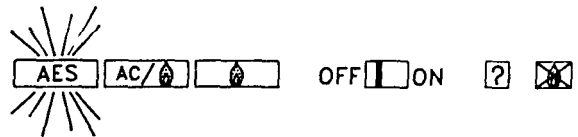

(56)

If the customer desires the selection to be made only between 120 volts and LP gas, the customer simply pushes the AC gas pushbutton. As soon as the button is energized the A.E.S. lamp will shut off and the AC gas pushbutton will illuminate green. This indicates the refrigerator will select only between 120 volts and LP gas, so that even while the customer is traveling, and 12 volts DC is available at the ignition lock terminal, the unit will not operate the 12 volt heating element. Instead, the system will select the LP gas mode while traveling.

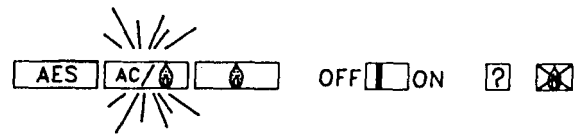

(57)

If the gas only pushbutton is depressed the lamp will illuminate green and the refrigerator will only operate on the LP gas mode, even if 120 or 12 volts are available.

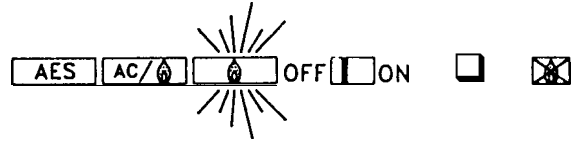

(58)

To the right of the main switch are four indicator lamps that provide information about the operation of the A.E.S. system. The four lamps are marked AC, 12 volts, a clock symbol, and the gas flame symbol.

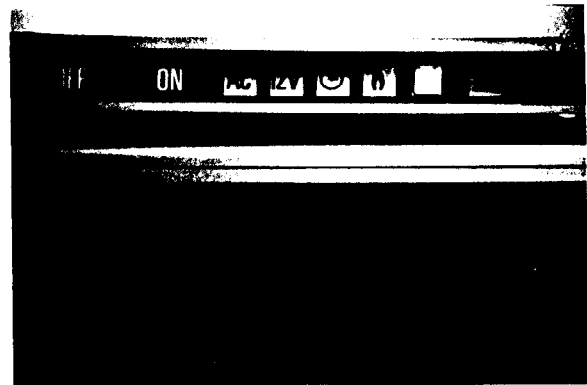

(59)

Anytime the customer wishes to know what source of heat the system is operating on, the question mark button may be depressed. The corresponding lamp will illuminate as long as the question mark button is pushed. For example, if the unit is operating on 120 volts AC and the question mark button is engaged, the AC lamp will illuminate.



(60)

If it is operating on the 12 volt heating element mode, the 12 volt lamp will illuminate.



(61)

If the coach pulls into a gasoline station and the refrigerator is in a safety delay, the clock symbol will illuminate.



55

(62)

Finally, if the unit is operating on LP gas, the gas symbol will illuminate.



(63)

As with other A.E.S. models, the third generation series has a flame failure indicator that will illuminate red if the system fails to light after approximately 3 minutes. This flame failure indicator will illuminate within 10 seconds, however, if no spark is achieved at the burner on the gas mode. A grounded electrode assembly may cause this condition. We will discuss the diagnostic steps to correct this situation in the troubleshooting section of our program.

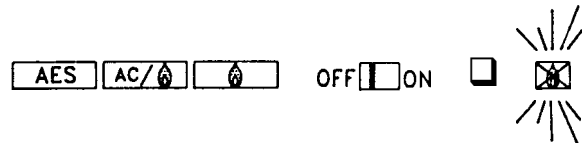

(64)

Another significant change in the third generation A.E.S. system is how the 12 volt heating element mode operates. As with the first and second generation series, the 12 volt heating element circuit is energized by the ignition lock terminal. This terminal receives its DC voltage from a wire that runs from the run side of the vehicle's ignition switch to the refrigerator's ignition lock terminal. This allows the 12 volt heating element to be energized only when the RV is traveling down the road.

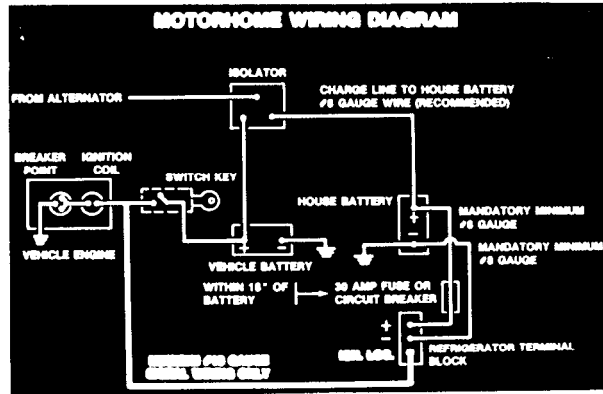

(65)

When the ignition lock terminal is energized by the ignition key, the printed circuit board must see at least 13.3 volts DC for a period of 40 seconds before the system will activate the 12 volt DC heating element.

TAG LINE ENERGIZED

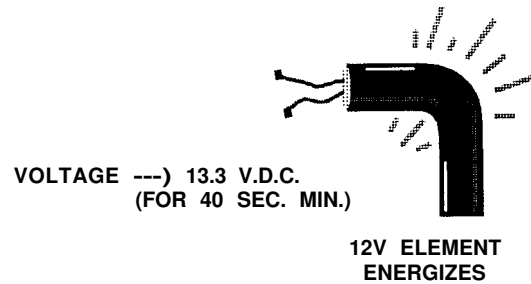

(66)

If 13.3 volts is not achieved in this time frame, the electronics will light the LP gas burner and the refrigerator will operate on the LP gas mode.

LOWER THAN 13.3 V.D.C. =



(67)

If at any time while traveling the DC voltage reaches the approximate 13.3 threshold, the LP gas flame will shut off and the 12 volt heating element will energize, continuing normal operation on the 12 volt mode.

TAG LINE ENERGIZED

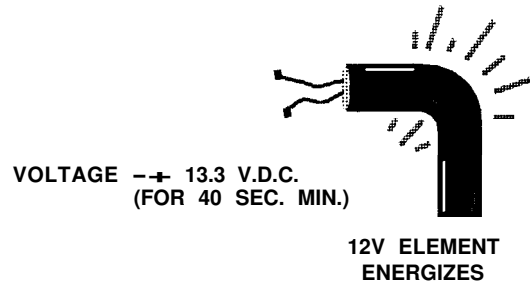

(68)

The voltage to the terminal block is continuously monitored by the printed circuit board, while the RV is traveling. Let's take a look at a couple of ways this battery protection system can be beneficial to the customer. First, suppose a customer has a weak or underrated alternator installed in the RV that is equipped with an RM3801. As the vehicle's ignition is turned on, the ignition lock terminal is energized by 12 volts, but because of the weak alternator, the printed circuit board can never see the 13.3 volts at the terminal block that is needed to energize the 12 volt heating element. So, the refrigerator will light and stay on the gas mode while the RV is traveling.

TAG LINE ENERGIZED

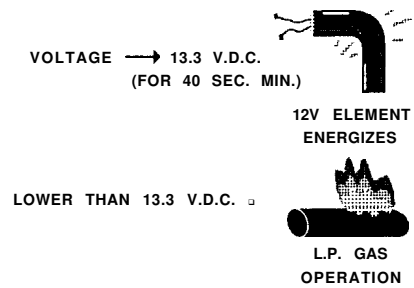

(69)

After a few hours of driving, the customer pulls into a gasoline station to refuel the vehicle. Even though the system is operating on the gas mode, as soon as the ignition key is turned off, the LP gas flame shuts off and the system initiates an approximate 25 minute time delay mode. This allows the customer to stop and refuel the coach without turning the unit off. As long as the ignition lock terminal is energized with 12 volts by the ignition switch, the system will always go into a safety delay when the ignition key is turned off. This will prevent an open flame at the burner when refueling.

TAG LINE ENERGIZED

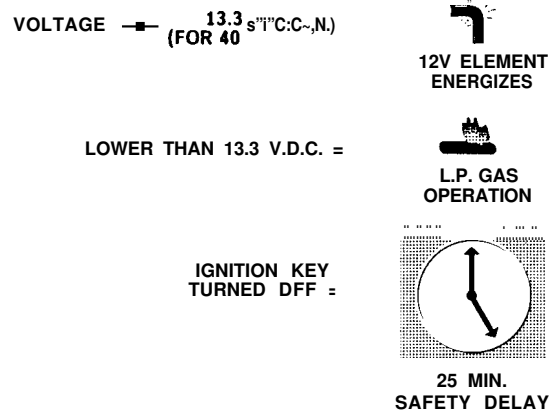

(70)

Secondly, suppose a customer has a properly wired RM3801 in a motor home that is equipped with a fully functional alternator. After the ignition key is turned on, the printed circuit board determines that at least 13.3 volts is available at the terminal block, so the 12 volt heating element engages.

TAG LINE ENERGIZED

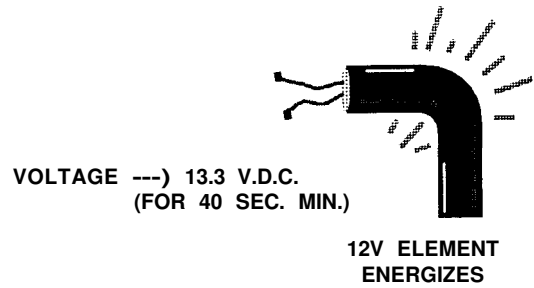

(71)

When the customer leaves on the trip it is a hot, muggy night so the vehicle's headlamps as well as the dash air conditioning system is turned on. After a few minutes of driving it begins to rain, so the windshield wipers are also turned on. With all of these components operating in the coach, the alternator has difficulty keeping up with the demand of the total coach load and the house battery begins to drain. As soon as the printed circuit board sees that the battery voltage going to the refrigerator has dropped to approximately 11 volts, the electronic circuitry will shut off the 12 volt DC heating element to protect the house battery. At this time, an approximate 25 minute delay cycle will be in progress.

LOWER THAN 11 V.D.C. =

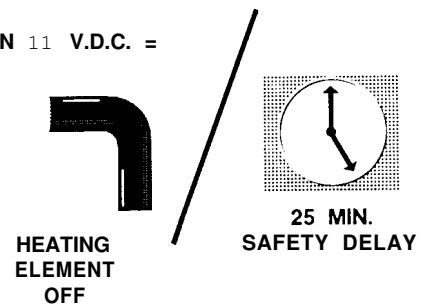

(72)

If the battery voltage remains low after the delay cycle, the automatic controls will light the refrigerator on the LP gas mode and stay on the gas mode until the printed circuit board sees approximately 13.3 volts DC to the terminal block.

LOWER THAN 11 V.D.C. =

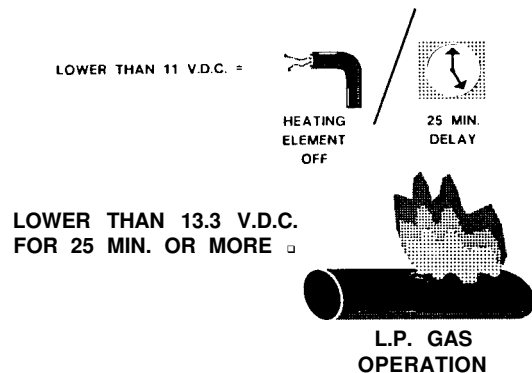

(73)

If at any time the battery regains itself to the approximate 13.3 volt threshold during the 12 volt cooling mode, the controls will again reengage the 12 volt DC heating element.

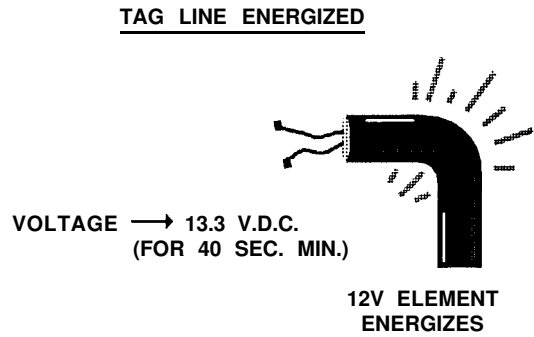

(74)

As with the first and second generation series A.E.S. models, any time the battery voltage to the terminal block drops to approximately 9.5 volts DC, the refrigerator will switch to a nonthermostatically regulated gas flame to insure the unit will still provide cooling for the customer. As a low battery indication, the green mode switch indicator lamp will shut completely off during the voltage drop.

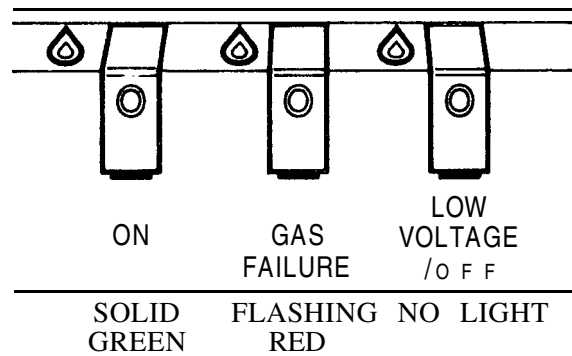

(75)

Before we take a look at diagnostic procedures for the A.E.S. refrigerators, let's discuss the external fuel and power source requirements for proper operation. 120 VOLT AC POWER - the refrigerator is equipped with a three prong, grounded AC plug for protection against shock hazards and should be plugged into a properly grounded three prong receptacle. Do not cut or remove the grounding prong from this plug.

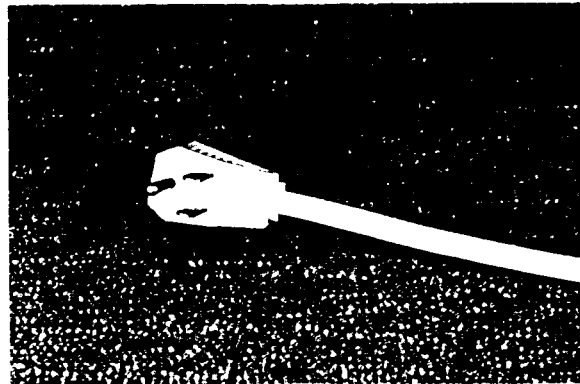

(76)

The power cord should be routed to avoid coming in contact with areas that become hot during normal operation or areas that could create a safety hazard. These areas include the burner cover, flue cover or the manual gas shut-off valve knob.

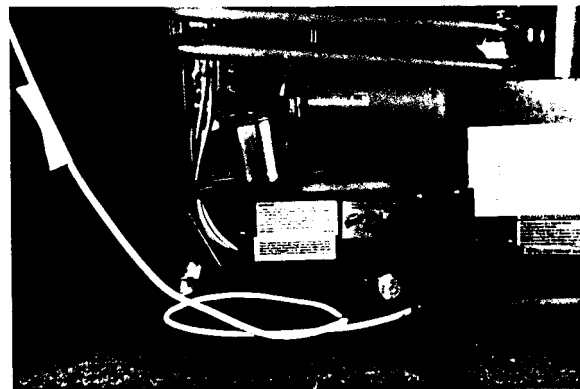

(77)

For proper cooling on the AC mode, the AC voltage to the refrigerator should not vary more than 10 percent from the voltage rating on the heating element. Heating elements used in Dometic refrigerators could have a rated voltage of 110 volts, 115 volts or 120 volts AC. Because of this, the power requirements for each differently rated heating element will vary. For example, if a heating element is rated for 100 volts, the acceptable power range would be between 99 to 121 volts AC. If an element is rated for 115 volts, the acceptable power range would be between 103.5 to 126.5 volts AC. If the heater is rated for 120 volts, the acceptable AC power range would be between 108 to 132 volts AC.

(see page A-6-24)

(78)

Refer to the voltage rating stamped on the heating element to determine if the voltage to the refrigerator is adequate to operate the system properly.

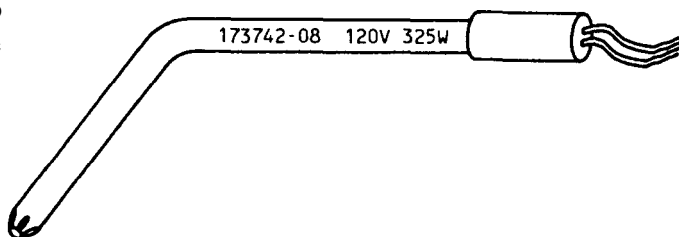

(79)

12 VOLT WIRING - for any A.E.S. to operate on any heat source the refrigerator must receive a 12 volt supply to the positive and negative connections on the terminal block at all times. The refrigerator must be connected directly to the house battery with 2 wires of adequate capacity to avoid a voltage drop.

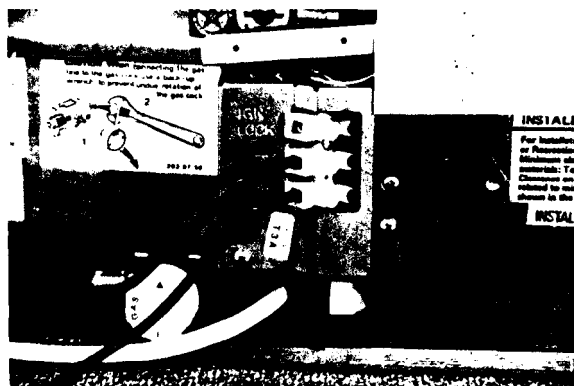

**RATED VOLTAGE ON
HEATING ELEMENT**

110V

115V

120v

AC OPERATIONAL RANGE

99 — 121VAC

103.5 — 126.5V AC

108 — 132VAC

(80)

As seen in the chart on page A-6-26, the gauge of wire required to the positive and negative connections on the terminal block will depend on the size of the refrigerator and the length of wire run from the house battery to the terminal block. This 12 volt circuit must be fused. The maximum fuse size should be 30 amps.

(see page A-6-26)

70

(81)

Be sure that a separate negative wire lead coming directly from the battery is connected to the negative terminal on the refrigerator and that a frame or chassis ground is not used as a substitute. Be certain that no other 12 volt equipment or lighting is connected to the refrigerator circuit. For the refrigerator to operate properly on any heat source, the terminal block must receive between 10.5 and 13.5 volts DC.

(see page A-6-27)

(82)

If any other technical information is needed when diagnosing or repairing any 12 volt circuit problem the technical data sheet can give you other beneficial information, such as heater wattages and amperage draws. (Refer also to Service Bulletin 28).

(see page A-6-28)

71

(83)

Please note that if a battery converter is used as the sole DC power source, the refrigerator will not operate properly. The pulsating DC power created by the converter will confuse the electronic circuitry into erratic operation and possible printed circuit board failure. When a battery converter is utilized in the installation, the circuit must be wired as shown in the diagram on page A-6-29.

(see page A-6-29)

**RECOMMENDED WIRE GAUGE AND LENGTH FOR
AES MODEL REFRIGERATORS**

<u>AWG</u>	<u>Maximum Wire Length</u>		
	<u>RM3500 RM663</u>	<u>RM3600 RM763</u>	<u>RM3800 RM1303</u>
10	19 ft.	13 ft.	N/A
8	31 ft.	22 ft.	19 ft.
6	49 ft.	34 ft.	31 ft.

1st and 2nd generation series models.

<u>AWG</u>	<u>Maximum Wire Length</u>	
	<u>RM3601</u>	<u>RM3801</u>
10	17 ft.	17 ft.
8	27 ft.	27 ft.

3rd generation models.

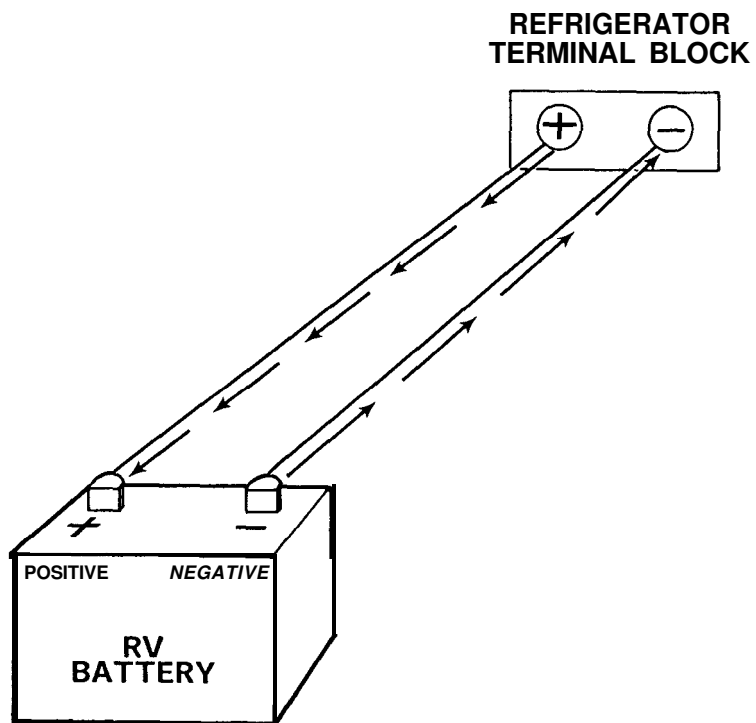

AES REFRIGERATOR TECHNICAL DATA

1ST GENERATION MODELS

MODEL NO.	COOLING UNIT PART NO.	ORIFICE SIZE & PART NO.	CORRECT FLOW METER READING	BTU INPUT BURNER	HEATER ELEMENT SPECS. Watt/Volts , Part No.		S. AC AMPS	DC AMPS	A/C Heater Resistance IN OHM'S	Electric Thermostat PART NO.	Gas Thermostat PART NO.
RM 663	928 3609 00/7	52 (200 7419 18/3)	.48	1226	210/120	0173738 048	1.8	17.5	67	292 05210012	0.522 00/2
RM 763	928 5319 00/1	53 (200 7419 19/1)	.52	1300	295/120	0173740 044	2.5	24.6	48	293 0523 00/2	293 0523 00/2
RM 1303	928 6169 00/9	58 (200 7419 21/7)	.60	1500	325/120	0173742 057	2.7	27	44	293 0523 00/2	293 0523 00/2

2ND GENERATION MODELS

MODEL NO.	COOLING UNIT PART NO.	ORIFICE SIZE & PART NO.	CORRECT FLOW METER READING	BTU INPUT BURNER	HEATER ELEMENT SPECS. Watt/Volt. , Part No.		AC AMPS	DC AMPS	A/C Heater Resistance IN OHM'S	Electric Thermostat PART NO.	Gas Thermostat PART NO.
RM 3500	293 4701 09/1	39 (200 7419 IS/Q)	.48	1000	185/120	0173738 063	1.5	16.4	80	200 7712 OS/S	200 7712 03/3
RM3600	293 4801 09/9	53 (200 7419 19/1)	.52	1300	295/120	0173754 046	2.5	17.9	48	293 0523 01/0	293 0523 01/0
RM3800	293 4901 09/7	58 (200 741Q 21/7)	.60	1500	325/120	0173742 081	2.7	17.9	44	293 0523 01/0	293 0523 01/0

3RD GENERATION MODELS

MODEL NO.	COOLING UNIT PART NO.	ORIFICE SIZE & PART NO.	CORRECT FLOW METER READING	BTU INPUT BURNER	HEATER ELEMENT SPECS. Watt/Volts , Part No.		AC AMPS	DC AMPS	A/C Heater Resistance IN OHM'S	Electric Thermostat PART NO.	Gas Thermostat PART NO.
RM 3601	293 4801 09/9	53 (2W 7419 19/1)	.52	1300	295/120	0175754 045	2.5	17.9	48	293 0814 01/3	293 0814 01/3
RM 2801	293 4901 09/7	68 (200 7419 21/7)	.60	1500	325/120	0173742081	2.7	17.0	44	293 0814 01/3	293 0814 01/3

PROPER WIRING OF AN AES WITH A BATTERY CONVERTER

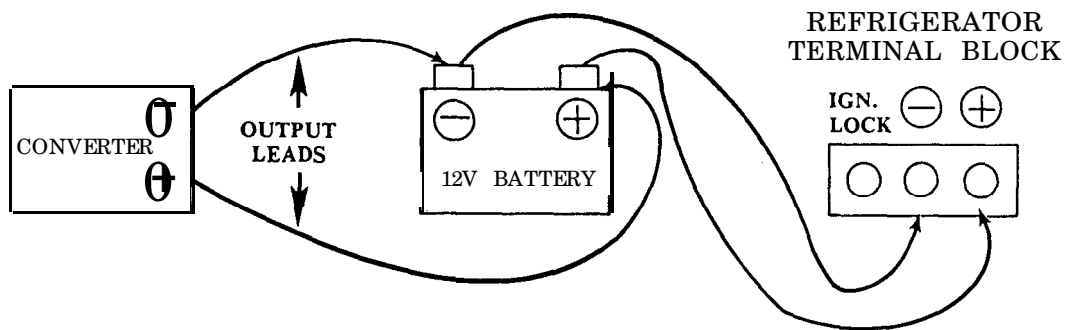

(84)

If the 12 volt circuit is wired as shown on page A-6-31, the battery will not be able to properly filter the converter voltage. This could cause erratic operation or premature printed circuit board failure. Remember, the positive and negative DC power leads to the refrigerator must come directly from the battery.

(see page A-6-31)

(85)

LP GAS SUPPLY - A.E.S. refrigerators use liquid petroleum gas (propane) that is adjusted to provide a pressure of 11 inches water column pressure at the refrigerator test plug; with at least 1/2 of the coach's LP gas load in operation.

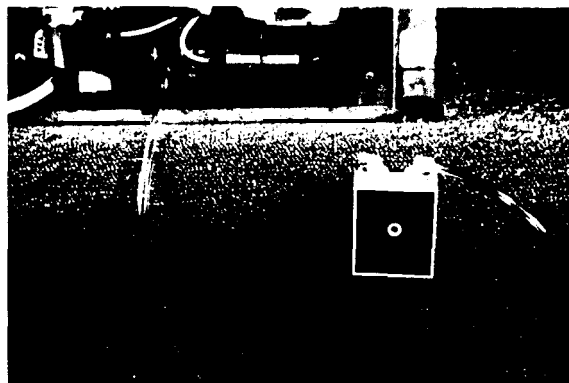

(86)

A periodic leak check of all the LP gas connections is recommended using a noncorrosive type of bubble solution. **WARNING: DO NOT use a flame to check for leaks.**

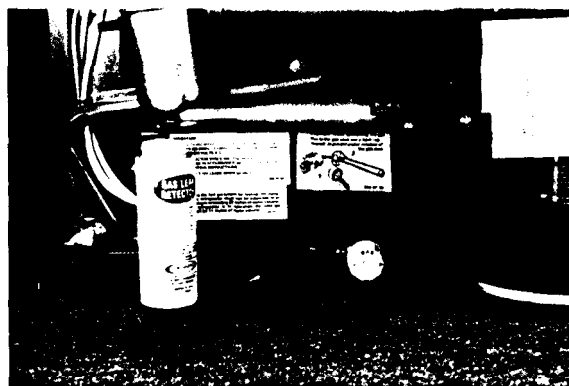

(87)

If, during the lighting sequence, attempts to start the LP gas flame are not successful, make sure the LP tank is not empty. Also, insure that all of the manual shut-off valves are turned on and are in the open position.



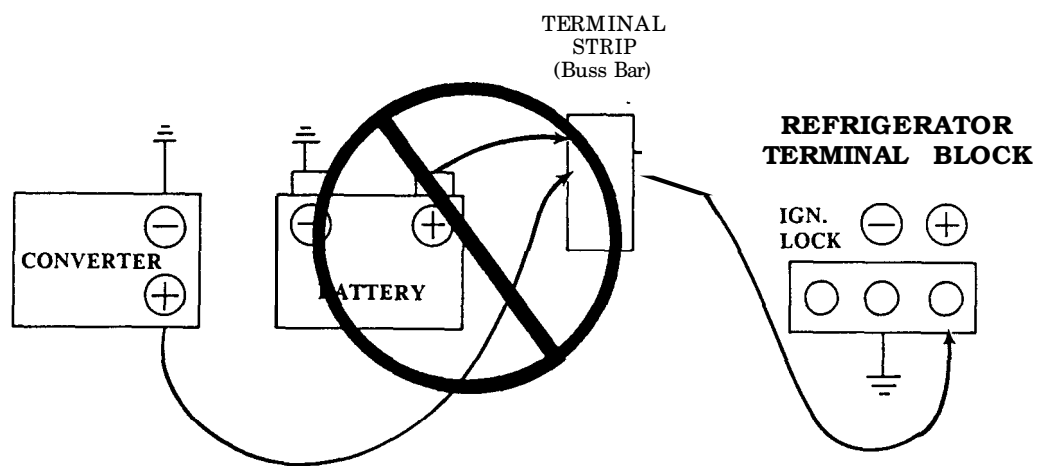

UNACCEPTABLE CONNECTION FOR AN AES

(88)

If the refrigerator has not been used for some time or if the main supply tanks have just been refilled, air may be trapped in the LP supply lines. To purge this air from the lines may require resetting the refrigerator two or three times before normal gas operation will begin.



(89)

We will now take a look at the troubleshooting procedures for the A.E.S. models RM3801 and RM3601. For diagnostic information on the first and second generation series models, refer to Service Bulletin No. 46. (See pages A-9- 1 to A- 10-2).

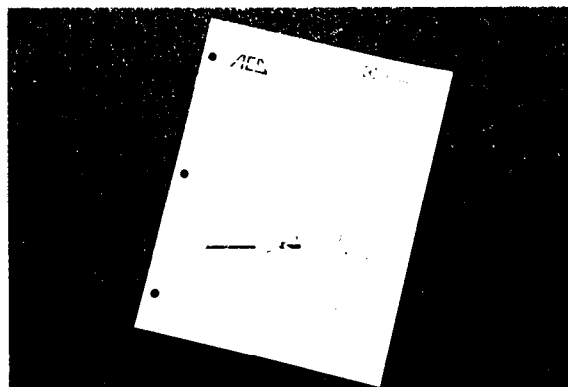

(90)

We will cover each of the four most common service problems separately and illustrate the steps needed to diagnose and repair the refrigerator properly. These situations include: NO operation, meaning the refrigerator will not operate on 120 volts, 12 volts or LP gas, NO 120 volt AC operation, 12 volt DC operation, and NO LP gas operation.

DIAGNOSTIC AREAS

1. NO OPERATION
2. NO 120 V.A.C. OPERATION
3. NO 12 V.D.C. OPERATION
4. NO L.P. GAS OPERATION

(91)

NO OPERATION. Whenever an A.E.S. refrigerator fails to operate on any heat source we must diagnose the components and circuits that are utilized by every heat source.

NO OPERATION

(92)

The first step to take is to insure that the 12 volt DC power supply and it's associated wiring is providing the proper DC voltage to operate the electronic circuitry correctly. Remember without a proper DC hookup to the refrigerator's terminal block, the unit will not operate on any heat source.

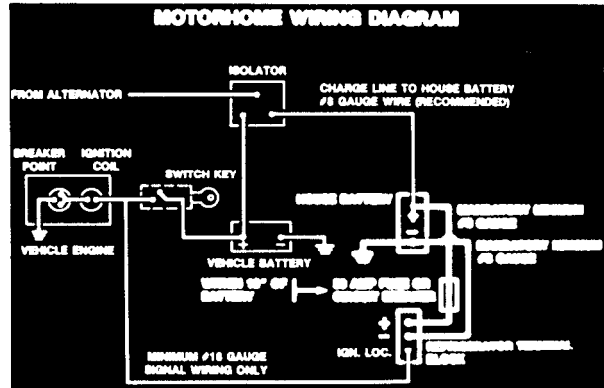

(93)

Check the incoming battery voltage at the terminal block to insure that between 10.5 to 13.5 volts are present and that the correct wire polarity has been utilized in the installation.

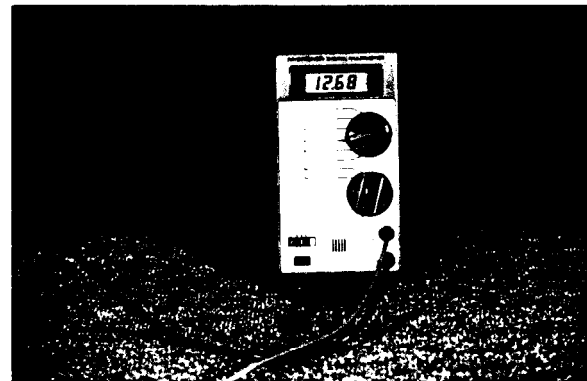

(94)

Second, make sure the negative battery lead connects to the negative connection on the terminal block and the positive battery lead connects to the positive connection on the terminal block. As we stated earlier in the program, check to see that the 12 volt refrigerator circuit is wired as shown in this diagram. Correct this if necessary. (Also see page A-6-27).

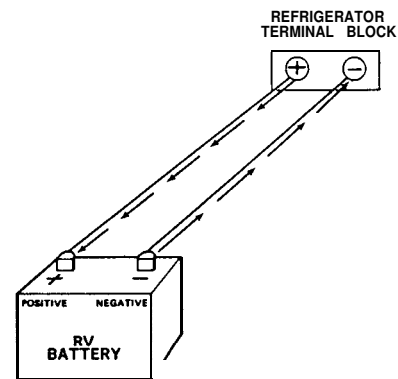

RECOMMENDED WIRE GAUGE AND LENGTH FOR AES MODEL REFRIGERATORS

AWG	Maximum Wire Length		
	RM3500 RM663	RM3600 RM763	RM3800 RM1303
10	19 ft.	13 ft.	N/A
8	31 ft.	22 ft.	19 ft.
6	49 ft.	34 ft.	31 ft.

1st and 2nd generation models

AWG	Maximum Wire Length	
	RM3601	RM3801
10	17 ft.	17 ft.
8	27 ft.	27 ft.

3rd generation models

(95)

Third, inspect that the proper gauge wire has been used as illustrated in the chart shown here. (Also see page A-6-26)

(96)

Check the 3 amp. DC fuse at the rear protection cover. If it is blown, check the 12 volt wiring on the coach and refrigerator for damage and repair, or replace if needed. When replacing the 3 amp. fuse do not substitute with an automotive quick blow type fuse, as it could needlessly blow during normal refrigerator operation.

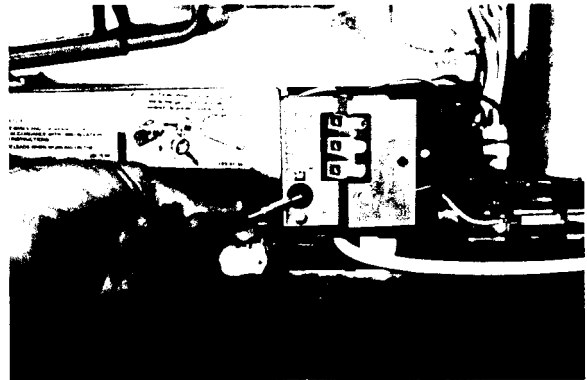

(97)

The next component to check in our diagnosis is the thermostat. If the thermostat or thermostat leads are defective the refrigerator will not operate on any heat source, as all heat sources are directed through this component in normal operation.



(98)

If it is believed the thermostat circuit is defective, first inspect the condition of the thermostat cable and see that it is correctly connected to the printed circuit board.



(99)

Next, gain access to the interior light thermostat assembly by removing the mounting screw and taking off the plastic cover to expose the thermostat and wire connections.

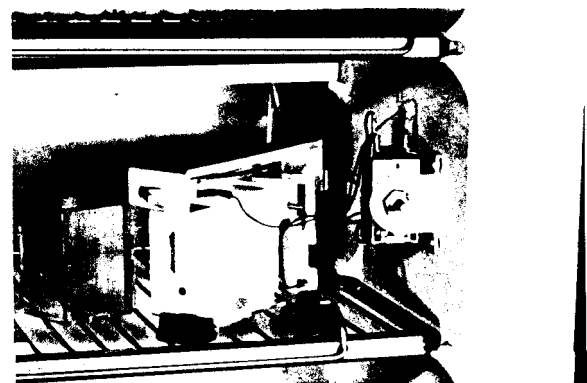

(100)

Remove the two thermostat leads and place them together using electrical tape. This will by-pass the thermostat from the electrical circuit. If the refrigerator begins operating when the leads are by-passed, the thermostat is defective and must be replaced. Be careful not to touch any surrounding metal parts with the thermostat lead ends when performing this procedure, as this will needlessly blow the 3 amp. protection fuse.

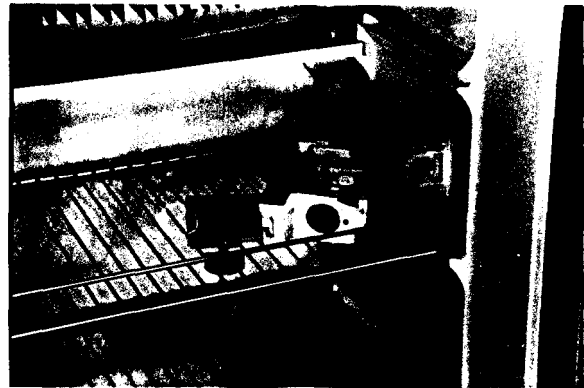

(101)

The main switch contains many different functions in the A.E.S. refrigerators, which includes controlling the heat sources. In this section we will discuss the troubleshooting procedures for the entire switch functions,, including the mode switch lamps as well as the function lamps. Before gaining access to the switch, visually inspect the switch cable for any cuts or shorts. Check to see that the plug connector is properly inserted into the **printed circuit board connection.**



(102)

Next, disconnect the positive and negative battery leads from the terminal block. All of our diagnosis on the switch will be made with continuity or ohm's resistance. Failure to disconnect the DC power supply during diagnosis could result in switch failure if it inadvertently touches metal.



(103)

Refer to the RM3801 switch diagnosis troubleshooting section of the A.E.S. Diagnostic Manual for a detailed explanation on how to troubleshoot these switches. (See pages A-8-1 to A-8-5)

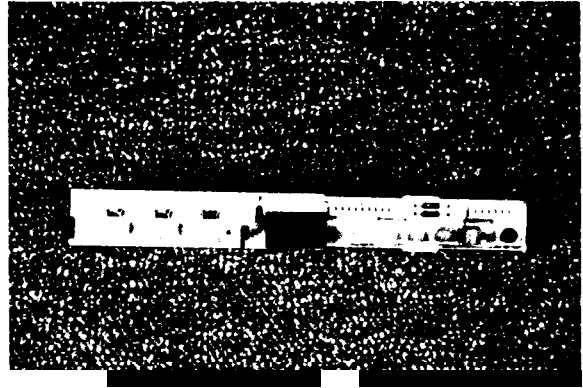

(104)

The next component to diagnose is the solenoid valve's internal winding. The A.E.S. control system uses the solenoid winding to provide a ground circuit to the printed circuit board for all modes of operation. If the solenoid winding is defective, the refrigerator will not operate on any heat source.

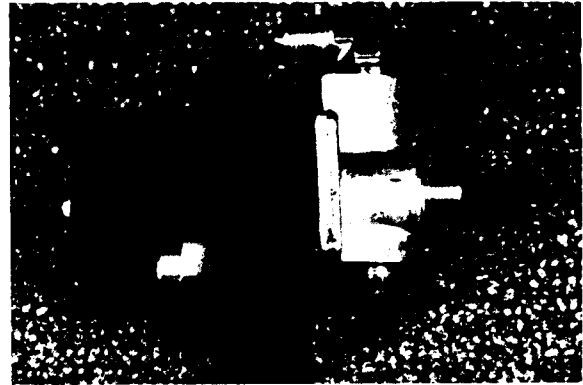

(105)

To check the solenoid winding, remove all power sources from the refrigerator, AC and DC and unplug the connector at the solenoid by pulling firmly outward.

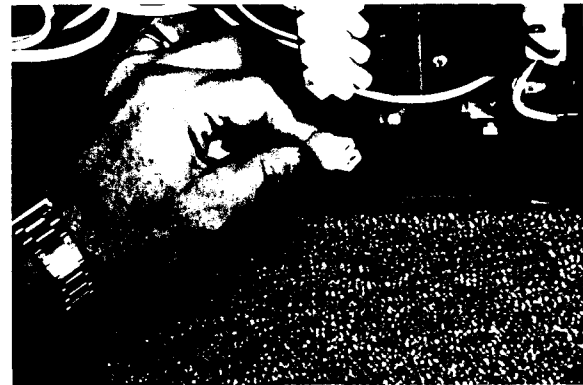

(106)

Measure the resistance value across the upper and lower terminals on the valve assembly. The proper valve should be 20 ohms with tolerance range of 10 percent. Values outside the tolerance range or no ohms reading would indicate a defective solenoid valve winding.

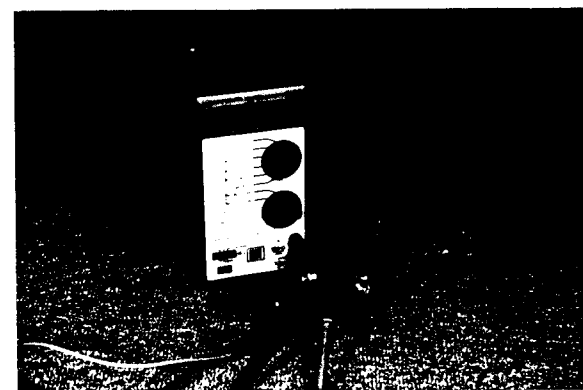

(107)

As in all of our troubleshooting steps, the **printed circuit board** is the last component to check for a failure. Insure that all of the connections on the board are clean and are inserted in their proper locations before attempting to determine if the **printed circuit board** is at fault.

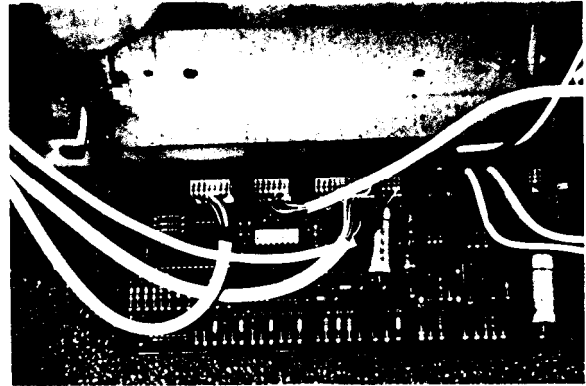

(108)

Many times when a circuit board failure is noticed it will be visible as a burned section on the board. Determine the cause of the board failure by referring to SERVICE BULLETIN R56-7A (pages A-11-3 to A-11-5) and correct the external problem before replacing the circuit board. FAILURE TO DO SO COULD RESULT IN REPEATED BOARD PROBLEMS.

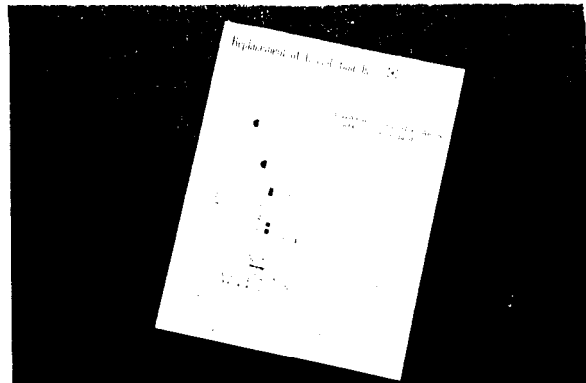

(109)

NO 120 VOLT AC OPERATION. To begin our diagnosis of the 120 volt mode, determine if the house battery and its associated wiring is adequate to operate the electronic circuitry properly, as we discussed in the "no operation" section of our program.

NO 120 V.A.C. OPERATION

(110)

Also, determine if the AC voltage to the refrigerator is within 10 percent of the rated stamped voltage on the heating element. Correct any wiring or voltage problems as needed to provide an adequate power supply to the refrigerator.

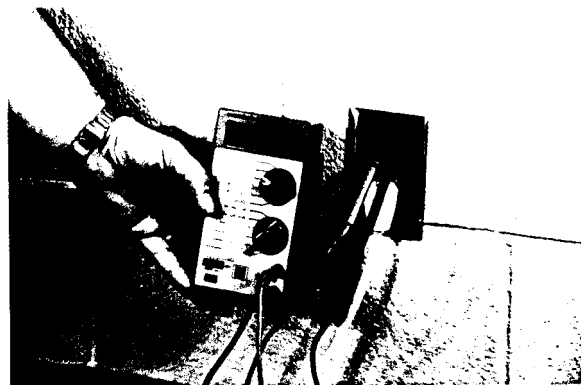

(111)

After we have determined that the correct AC and DC power is available to the refrigerator, we need to diagnose the 120 volt heating element. Generally speaking, when a 120 volt heating element does not deliver the proper amount of BTU's, it does not heat up at all. In some cases, however, a heating element may be just partially defective. In either case, the troubleshooting steps are the same to determine if the element is at fault.

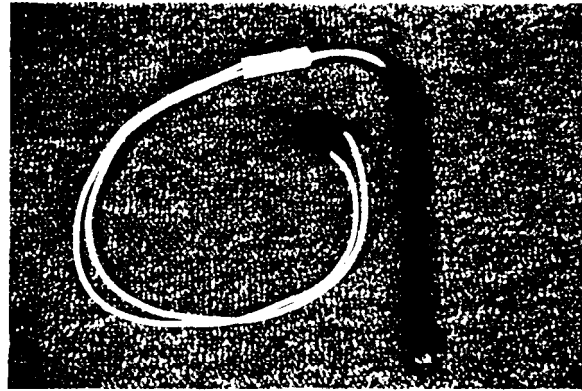

(112)

Remove the 120 volt power cord from the wall outlet and gain access to the heater leads on the printed circuit board by removing the necessary protection covers.



(113)

Remove the leads and measure for proper resistance across the two heater leads with a properly calibrated ohm meter. Refer to SERVICE BULLETIN 28 or the AES TECHNICAL DATA SHEET on page A-6-28 to determine if the ohms value obtained is the proper reading for the model you are working on.

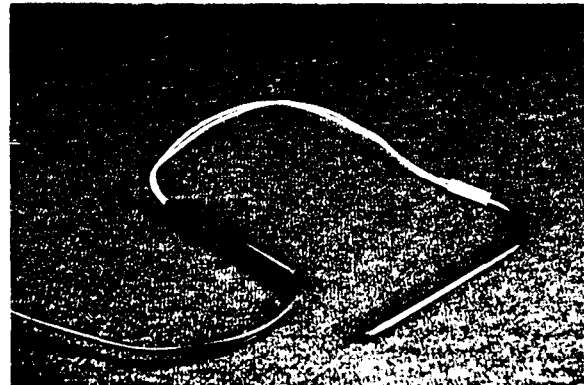

(114)

Shown here is an example of the information available in this bulletin. As with most of our electrical checks, an acceptable tolerance range on the ohms valve obtained is 10 percent. If the ohms value on the heating element does not fall within the necessary tolerances, the element is defective and must be replaced.

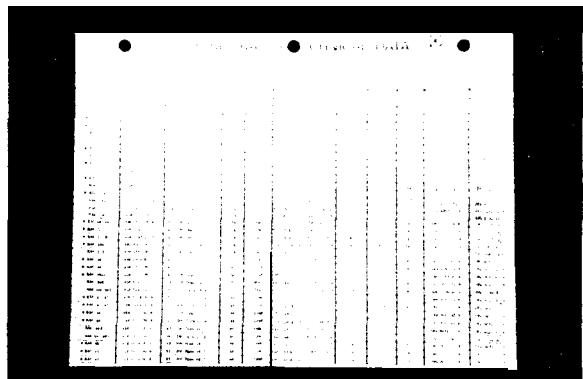

Model	Ohms	Resistance	Notes
Model 1	100	100	
Model 2	100	100	
Model 3	100	100	
Model 4	100	100	
Model 5	100	100	
Model 6	100	100	
Model 7	100	100	
Model 8	100	100	
Model 9	100	100	
Model 10	100	100	

(115)

Do not diagnose the heating element by checking only for continuity. A continuity check does not properly check the integrity of the element. If a zero ohms reading is indicated, an internal short is present in the heating element. Heater replacement would then be necessary.

**DO NOT DIAGNOSE THE
HEATING ELEMENT BY
CHECKING
ONLY FOR CONTINUITY**

(116)

At this time, also inspect the printed **circuit board** for burned marks or damaged board components using SERVICE BULLETIN R56-7A (pages A-1 1-3 to A-1 1-5). Whenever diagnosing 120 volt problems always remember to verify the heating element's ohms resistance. A shorted 120 volt heating element can cause permanent printed circuit board failure. (See pages A-1 1-3 to A- 1 1-5)

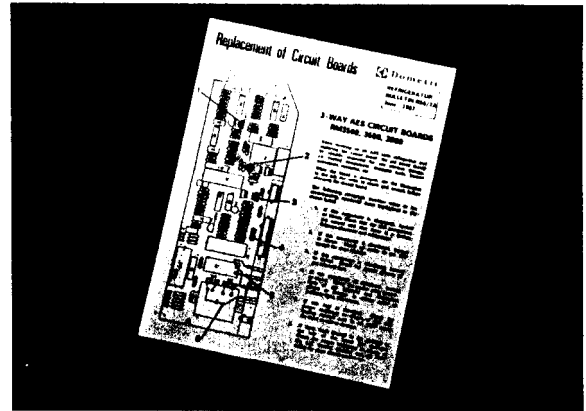

(117)

After diagnosing the heating element, insure that all of the connections on the module board are inserted correctly and that there are no damaged leads that could cause circuit board failure.



(118)

Next, diagnose the switch by following the switch diagnosis section of the A.E.S. manual which we have previously discussed. As a final **check** in our diagnosis of the 120 volt circuit, visually inspect the refrigerator power cord. If necessary check the cord end to end for continuity on the ground black and white wires that make up the power cord. If no continuity is indicated on one or more of the power cord wires replace the power cord. During this diagnostic step be sure that the power cord leads are firmly connected to the AC terminal block.

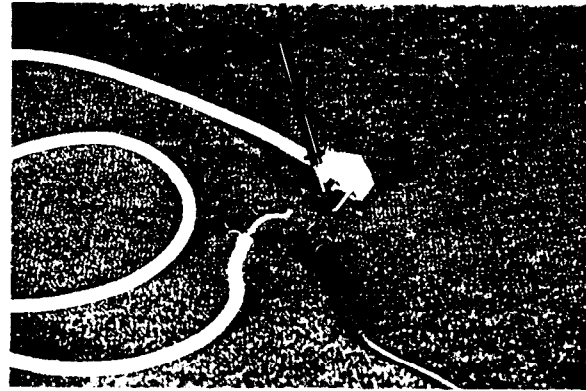

(119)

NO 12 VOLT DC OPERATION. As we mentioned earlier in the program, the ignition lock terminal houses the wire connection that controls the 12 volt heating element circuit and the 25 minute delay cycle.

NO 12 V.D.C. OPERATION

(120)

The wire from this terminal should be routed directly to the run side of the vehicle's ignition switch. This will provide DC voltage to the ignition lock terminal only when the vehicle is in motion. It also allows the vehicle's alternator to keep the house battery charged and eliminates a possible dead battery due to the customer forgetting to switch off the refrigerator. Whenever the ignition key is turned off, the electronic control system will initiate a 25 minute delay cycle. When the vehicle's ignition is turned back on the system will re-energize the 12 volt DC circuit. The ignition lock wire, which is commonly referred to as the "tag line", should be a wire size of at least 16 gauge. The amperage demands from the element are handled by the positive and negative leads of the terminal block, which necessitates the need for larger wire gauge requirements.

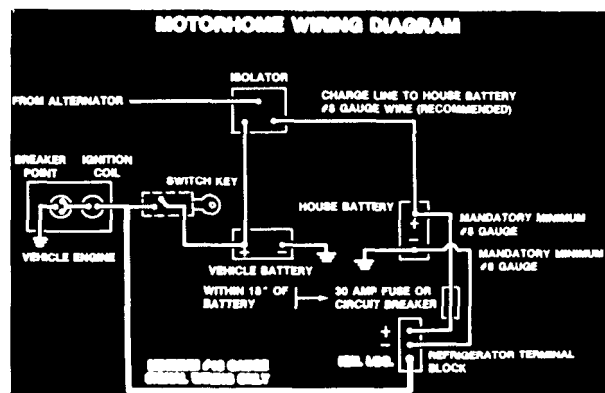

(121)

When beginning to diagnose the heating element circuit, keep in mind that an approximate DC voltage of 13.3 to the terminal block is required to engage to 12 volt DC heating element. Any voltage lower than 13.3 will prevent DC operation and the refrigerator will operate on the LP gas mode.

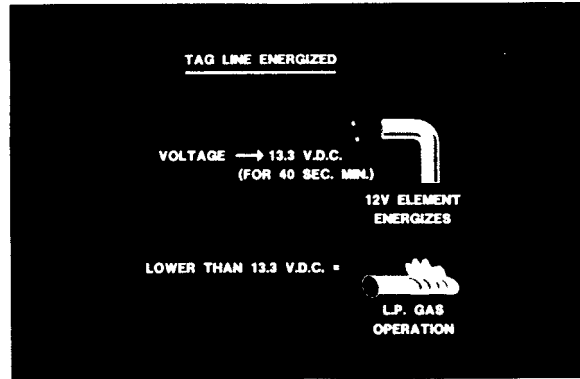

(122)

After verifying that the 12 volt battery circuit is wired properly and that the proper gauge wire size has been utilized. Check the DC voltage at the terminal block to insure that at least 13.3 volts is available to energize the 12 volt heating element.

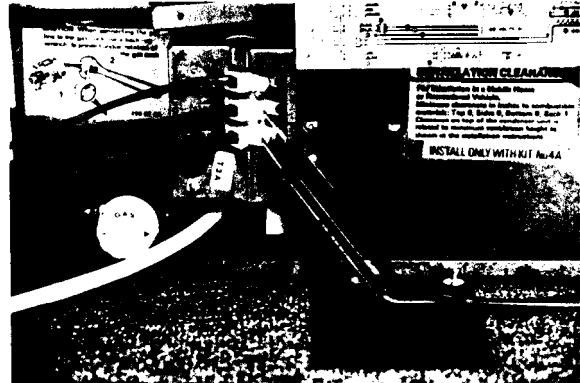

(123)

If proper voltage is available at the terminal block and the refrigerator is still not operational on 12 volts, the DC relay needs to be diagnosed.

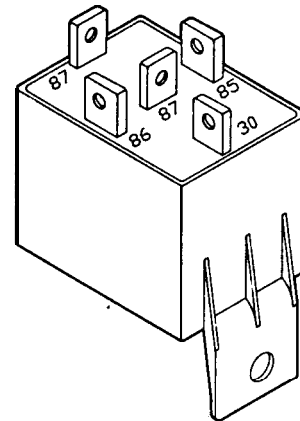

(124)

Gain access to the relay and make sure the ignition switch is turned to the off position and voltage is not present at the ignition lock terminal. DC voltage should be present between terminals 85 and 30 on the relay. If voltage is not present, recheck all 12 volt connections. Pay close attention to the connections on the positive terminal, as this is where the 30 terminal attaches.

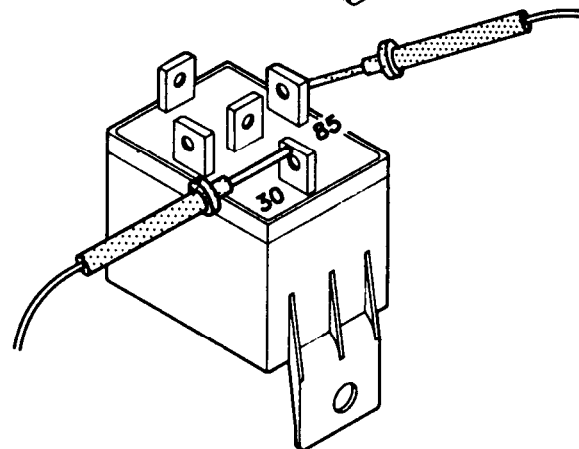

(125)

DC voltage should not be present between terminals 85 and 87 on the relay when the ignition key is disengaged. If voltage is present at these terminals the relay is defective and must be replaced.

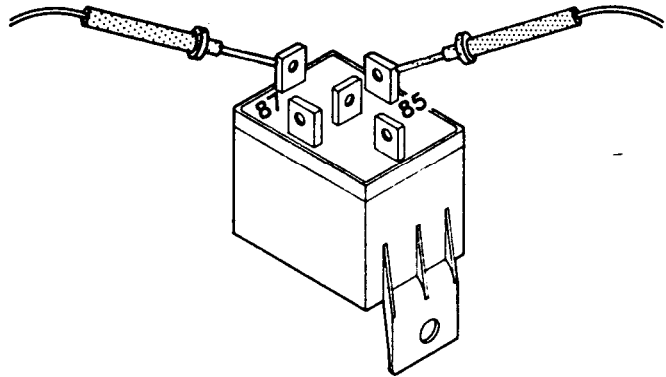

(126)

Next, energize the vehicle's ignition switch and check for voltage between terminals 85 and 86 on the relay. Voltage should be present. If no voltage is present between these terminals, other components and connections are suspect, such as the switch, thermostat or circuit board.

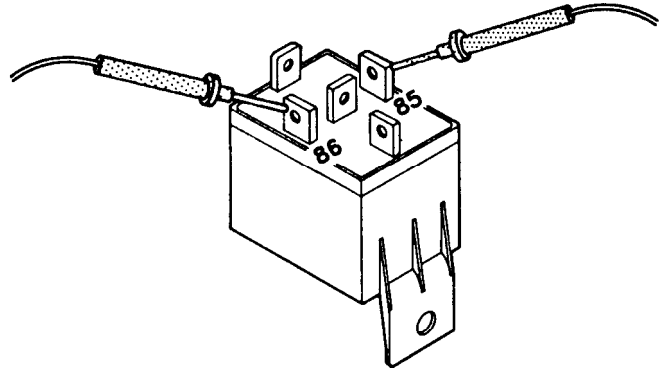

(127)

As our final test of the relay, check for voltage between terminal 85 and 87. If no voltage is present the relay is defective and must be replaced.

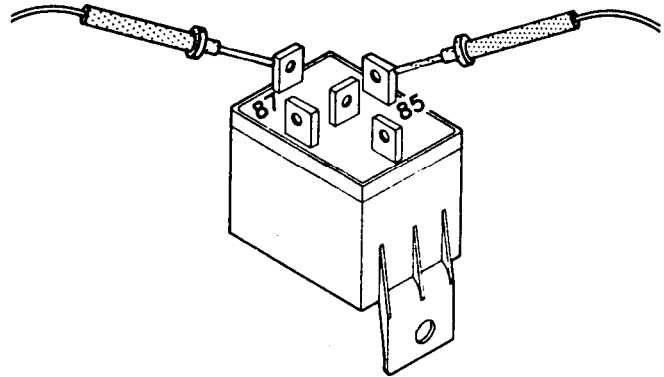

(128)

A defective 12 volt heating element will also cause the refrigerator not to operate on the DC mode. Disconnect the heater lead that attaches to the 87 terminal on the DC relay and the lead that attaches to the refrigerator grounding strip.



(129)

Measure resistance across the leads as outlined earlier in our program for the 120 volt heating element. The reading, however, will be different from the AC heating element. For the models RM3601 and RM3801 the ohms resistance should be .67, with a tolerance range of 10 percent. If there is no ohms reading or a reading outside the 10 percent tolerance range, the heater is defective and must be replaced. Please note that it will take a very precise ohm meter to accurately read this measurement.

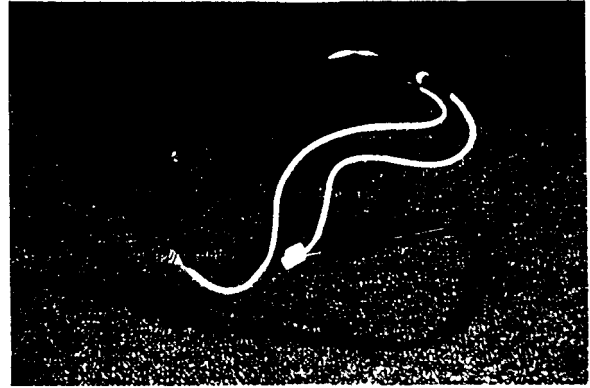

(130)

A malfunctioning switch assembly may also affect the DC mode. As outlined in previous diagnostic steps in our program, diagnose the switch for proper operation. In our final check of the 12 volt cooling system, check all wiring harnesses and leads for shorts or opens. If necessary use an ohm meter, end to end, on the suspect leads.

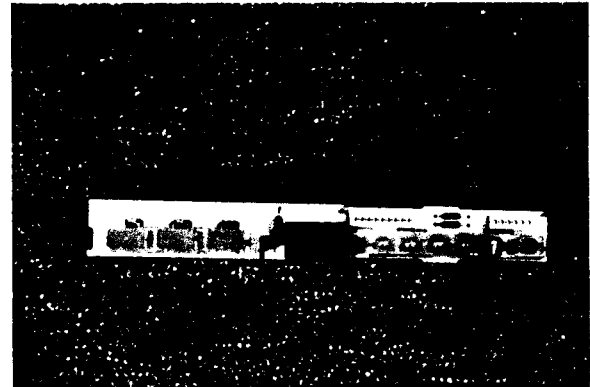

(131)

NO LP GAS OPERATION

NO LP GAS OPERATION

(132)

To diagnose a gas operational problem be sure the refrigerator is in the A.E.S. mode.

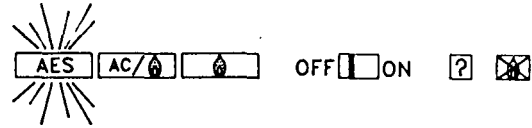

(133)

The first diagnostic step is to be sure there are proper DC volts at the terminal block, in accordance with the previous explanation on the DC power source. (See pages A-6-33 through A-6-34, paragraphs 92-96)

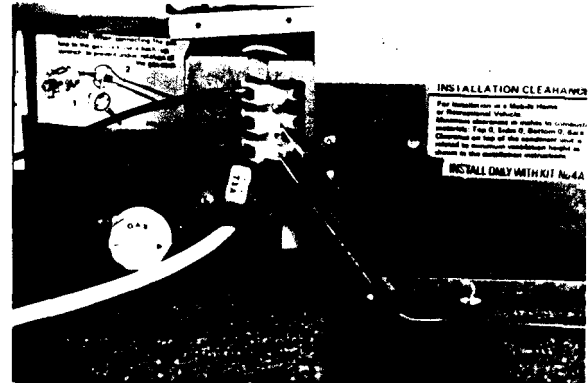

(134)

Next, check to be sure the 120 volt power cord to the refrigerator is unplugged from the receptacle. Then check for voltage at the terminal block between the ignition lock terminal and the negative terminal. If any voltage is present you will not be able to have gas operation. These must be corrected before any further checks can be done.

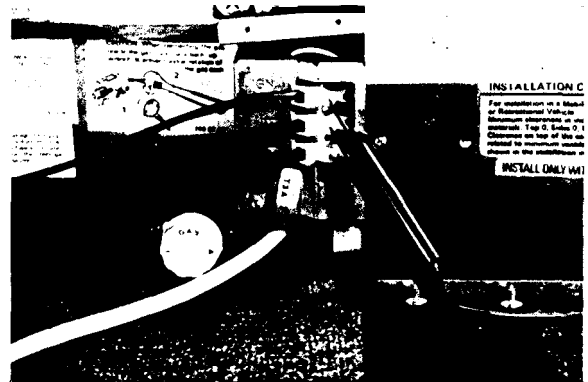

(135)

Now that we have proper DC voltage, no 120 volt and the ignition lock is not energized, we can start to diagnose the gas system. Be sure the manual gas shut-off valve is in the off position. Remove the twelve (12) millimeter gas test port plug and install a 1/8 NPT fitting in its place.



(136)

Now hook up a manometer to the test fitting and leave it in place until all checks have been made for gas operation. Turn the shut-off valve and refrigerator on and check for a gas pressure reading. A correct reading would be eleven (11) inches water column pressure. If needed, adjust the main gas regulator at the LP gas tanks.

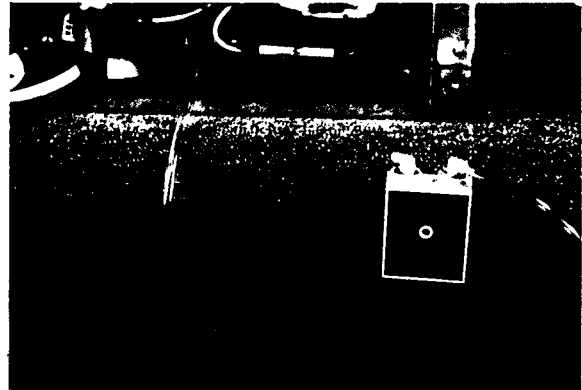

(137)

If you do not obtain any pressure, you must check the electric solenoid. To diagnose the electric solenoid windings, do the ohms resistance check that was discussed earlier in this program. (See page A-6-36, paragraph 106)

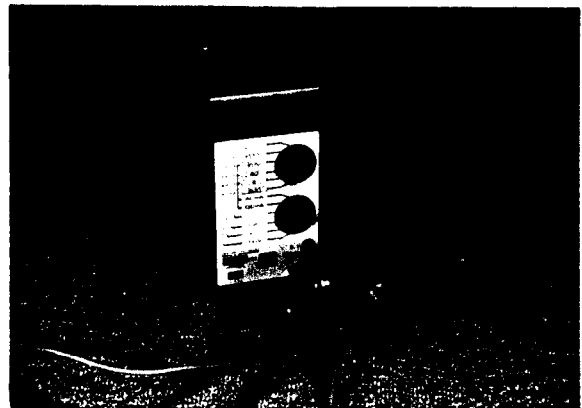

(138)

Another check is to disconnect the electric solenoid wires. Supply DC voltage to the BOTTOM terminal of the electric solenoid by means of a temporary jumper wire from the positive terminal on the terminal block.

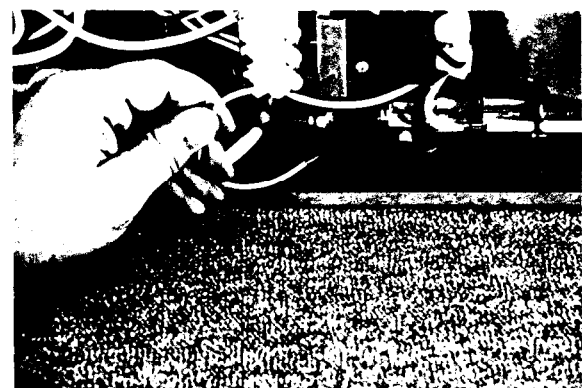

(139)

You should hear a sharp click from the solenoid and now obtain a gas pressure reading. If these results are not realized the solenoid is defective and must be replaced.

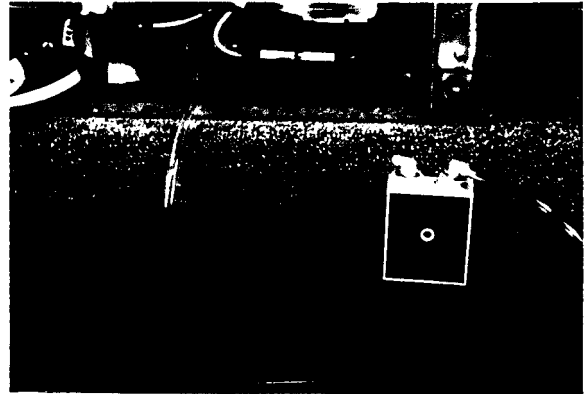

(140)

If these results are correct you must next check the wires that connect to the solenoid voltage. The results should be close to the voltage coming to the appliance.



(141)

We will now **check the igniter-reigniter assembly**. First turn the unit on and check for voltage between the positive and ground terminals on the igniter. If you obtain a DC voltage reading, the igniter is receiving power.

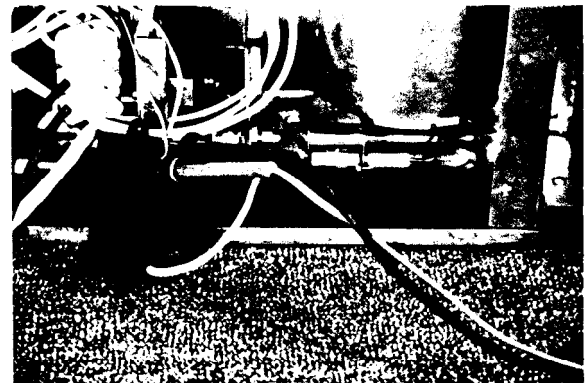

(142)

If you do not obtain a reading, move the meter probe from the ground terminal of the igniter to the negative terminal on the terminal block. If you now have a reading on the meter and you did not at the igniter, you have a problem in the ground circuit. If you obtained a reading on both the tests, the igniter is receiving power.

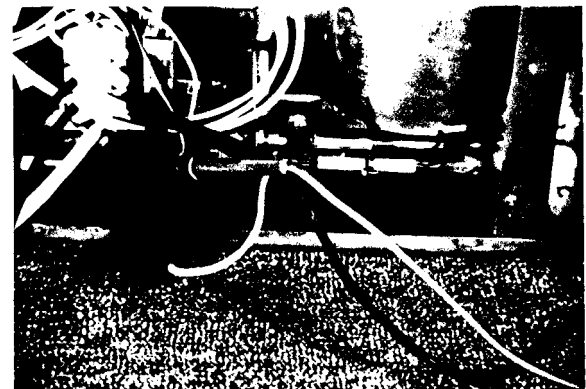

(143)

The next diagnostic step is to turn the unit off and then remove the high voltage wire from the igniter. When the unit is turned on you should hear a sharp clicking sound from the igniter. If no sound is detected, replace the igniter. When sound is present the igniter is good.

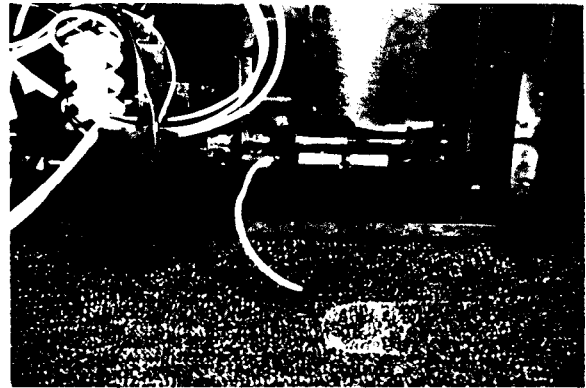

(144)

If the igniter checks good and there still is no spark at the electrode, you must check the high voltage wire and electrode. Make a visual check of the high voltage wire for any defects or broken insulation on the wire that could allow the high voltage to go to ground. Also, check the wire that has been disconnected at each end for continuity.



(145)

The electrode spark gap must be set at three sixteenths ($3/16$) of an inch to provide a proper spark. The spark gap is the distance between the burner and the tip of the electrode.

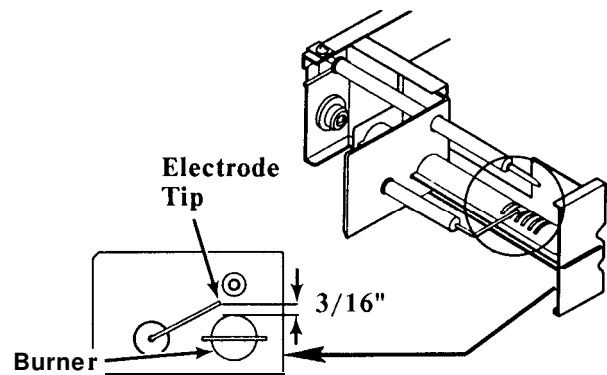

(146)

You would next check the electrode for any visual cracks or breaks on the ceramic portion. If you have a good igniter and high voltage wire and still do not have spark at the tip of the electrode, replace the electrode.

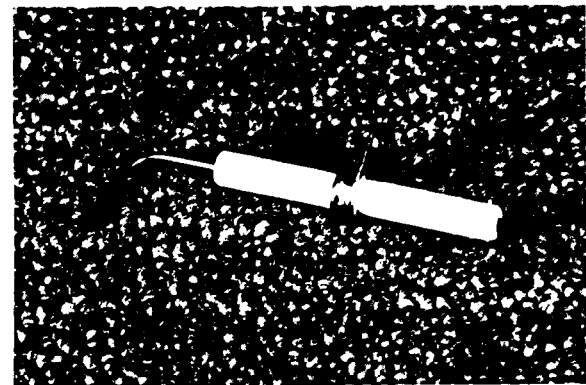

(147)

A very important function of the igniter assembly is to measure the condition of the flame. The flame completes the high voltage circuit and the spark stops when enough flame is present.



(148)

If all of the diagnostic steps have been completed with positive results and you are still experiencing lack of cooling, be sure the orifice, burner and flue tube have been cleaned. To clean the orifice use an alcohol based solvent and air. **NEVER use a drill bit or jet tip cleaner to clean any orifice**, as these devices will damage the factory machined part and **CREATE A POTENTIALLY DANGEROUS SITUATION.**

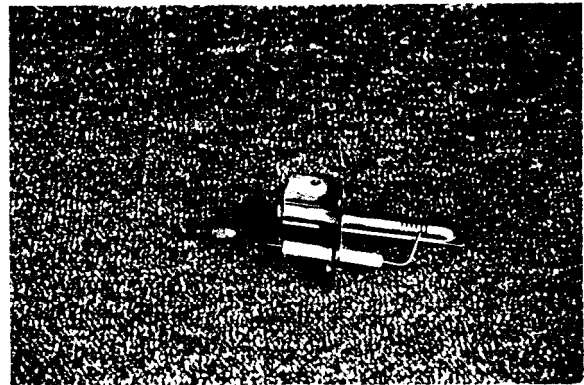

(149)

To properly clean the flue tube we would suggest obtaining a flue brush. The part is available through your local Dometic/Duo-Therm distributor.

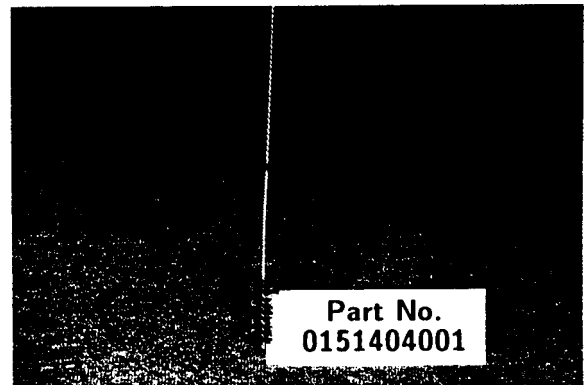

(150)

Now that we understand how to troubleshoot and repair the A.E.S. controls, do not forget that you must have the basics of proper heat, ventilation and leveling for the absorption cooling unit to operate effectively.

BASIC'S OF PROPER COOLING UNIT OPERATION

HEAT
VENTILATION
LEVELING

(151)

If you require additional service assistance the basic requirements for the cooling unit operation or the A.E.S. control system, please refer to our manual refrigeration or A.E.S. training manuals. For day-to-day technical service assistance contact the technical service department.



(152)

You are an essential part of a team that contributes greatly to the successful future of the RV industry, your dealership and The Dometic Corporation.

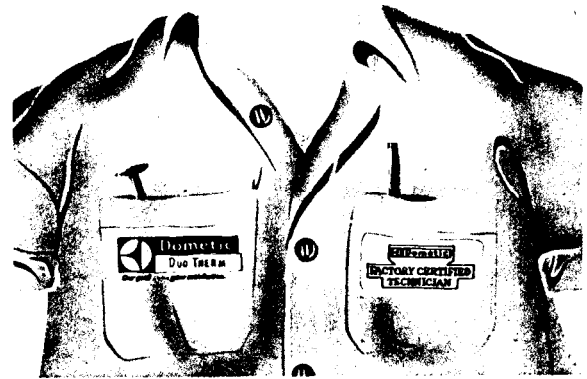

AES Refrigerator

GLOSSARY OF TERMS

AES Automatic Energy Selector Refrigerators. First introduced in 1983, the 1st and 2nd generation series will automatically select the available heat source for operation (120V AC, 12V DC or LP gas) by simply turning the refrigerator to the "ON" position. The 3rd generation series have the added flexibility of being utilized in three (3) individual selector switches, the refrigerator can be operated as a full AES, on 120V and LP gas only or gas operation only.

AUTOMATIC IGNITER/REIGNITER - An electronic 12V DC device that directly replaces the piezo lighter, found on manually controlled models for several years. When 12V DC is supplied to the igniter it produces a high voltage that is supplied through the electrode cable and electrode which produces a spark at the burner to light the air/gas mixture. An added benefit of this system is that 12V is supplied continuously to the igniter during the gas mode. If the flame should blow out, the igniter will re-engage and relight the flame at the burner. An additional function of the igniter is that it produces an increased DC voltage that ultimately opens the solenoid valve.

BURNER - A slotted metal tube located just below the flue tube on the cooling unit, an integral part of the gas system. This is where the igniter spark occurs which produces LP gas flame at the burner that produces the necessary heat to initiate the cooling process at the cooling unit. Both orifice and burner should be cleaned periodically to maintain proper cooling capabilities of the refrigerator.

DELAY CYCLE - If refrigerator is wired to the installation according to Dometic's specifications, every time the ignition switch is turned to the "OFF" position, following 12V cooling operation, a safety delay cycle begins. For approximately 25 minutes the refrigerator will remain off and will not select LP gas operation. This is to insure there will not be an open flame at the burner while the customer refuels the R.V.. The 120V cooling mode is not affected by the delay cycle. Anytime the refrigerator receives 120V at the power cord, the unit will operate on the AC mode. On the 3rd generation series models this safety delay cycle has been incorporated into the controls to protect the 12V DC cooling circuit as well. If battery voltage to the terminal block drops below 11V DC when the refrigerator is operating in the 12V DC mode, the controls will disengage the 12V heating element and go into a delay cycle. As soon as battery voltage regains proper voltage (13.3V DC) the delay cycle will discontinue and refrigerator will operate on 12V DC cooling mode. If voltage does not regain itself after approximately 25 minutes, the controls will select gas operation to insure proper cooling. This delay cycle may be over-run (see Off/On Procedure, Item 24).

AES Refrieerator GLOSSARY OF TERMS continued

ELECTRODE - The angular piece of metal located just above the burner that is connected to the high voltage cable. High voltage ‘jumps’ the air gap between electrode and burner, and creates the sparking seen at the burner. This circuit is grounded by the gas flame which stops the sparking produced by the igniter. For igniter/high voltage cable/electrode assemblies to operate correctly, the electrode must be positioned properly. The air gap distance between electrode and burner should measure approximately 3/16"

GAS PREVENTION SAFETY DEVICE - The AES has a safety circuit that will prevent sparking and gas ignition on the gas mode if one of the following conditions occur:

- A. Printed circuit board failure
- B. Igniter failure
- C. No voltage is present at positive and negative connections at the terminal block

This safety circuit is designed to insure that LP gas will not accumulate at the burner due to a part failure.

HEAT INPUT - One (1) of three (3) requirements for proper operation with absorption refrigerators. This specification is critical to maintain proper cooling properties of the cooling unit. With too little heat at heating element or burner, the ammonia in the cooling unit will not vaporize (boil off) properly and a lack of cooling will result. An excessive amount of heat to the cooling unit will cause the water, as well as ammonia, to vaporize, causing the cooling process to stop. Since as little as 25 BTU’s input can dramatically affect operation of the cooling unit, it is NOT recommended to substitute heating element sizes or burner orifice values. Whenever diagnosing heat input problems, refer to Service Bulletin No. 28 or the AES Technical Data Sheet on page A-6-28.

HEATING ELEMENTS - Self-contained heat generating devices operating off either AC or DC voltage that supplies heat to generator section of the cooling unit.

HIGH VOLTAGE ELECTRODE CABLE - Cable that transmits high voltage, produced by the igniter, and sends it to the electrode. High voltage from the igniter results in sparking at the burner assembly which lights the air/gas mixture at the burner. This cable should always be disconnected when diagnosing the igniter. If the cable is shorted to ground the result will be no spark on LP gas operation.

AES Refrigerator GLOSSARY OF TERMS continued

INDICATOR LAMP(S) - Consisting of light emitting diode(s) (L.E.D.) the 1st and 2nd generation series refrigerators will illuminate green when main switch is turned to the "ON" position. If refrigerator fails to ignite after trial for ignition sequence (2-3 minutes), the green L.E.D. will shut off and a red L.E.D. will flash on and off, indicating a flame failure. If the incoming battery voltage to the terminal block drops to approximately 9.5V DC, the indication lamp will shut off indicating a low voltage situation. The 3rd generation series utilizes three (3) separate green L.E.D.'s that are located behind the mode selector pushbuttons. If this series goes into flame failure, a separate L.E.D. will illuminate orange to indicate this condition.

LEVELING - One of three (3) requirements for proper operation with absorption refrigerators. The absorption design utilizes no mechanical pumps or compressors to circulate the refrigerant within the system, so proper leveling must be maintained to provide the correct refrigerant flow. Without proper leveling, refrigerant within the cooling unit will collect and stagnate at certain areas. Without proper refrigerant flow, the cooling process will stop. Cooling units that utilize an exposed siphon pump tube at the generator section (units with square boiler boxes) require a precise leveling check. To properly level these units a spirit (bubble) level is placed on the floor of the freezer compartment. To insure operation with the refrigerator when the coach is positioned in a stationary (standing) manner, the bubble must be at least 3/4 inside the central ring.

Important: Permanent damage can result to the square boiler box units if proper leveling is not maintained. In recent years Dometic has engineered a new type of cooling unit that utilizes an enclosed pump tube surrounded by a weak ammonia solution to protect the assembly. These units are evidenced by a **circular** boiler box cover. To insure proper leveling in these units, the vehicle needs to be leveled only so it is **comfortable to live in** (no noticeable sloping of floor or walls).

When the vehicle is moving leveling is not critical as the rolling and pitching movement of the vehicle will pass to either side of level, keeping the ammonia from accumulating in the piping.

LP GAS TRIAL FOR IGNITION (Lockout) - Similar to a DSI R.V. furnace, AES refrigerators incorporate a timed lighting sequence that is controlled by the printed circuit board. When the controls select LP gas operation, high voltage sparking from igniter and LP gas solenoid are energized. Normally in just a few seconds spark will ignite air/fuel mixture at the burner and remain burning until thermostat is satisfied or refrigerator is turned off. If there is air in the gas line, or the R.V. rig has not been used for a long period of time, this lighting procedure may take up to 2 to 3 minutes to establish a flame. For this reason the AES refrigerator will attempt to light the refrigerator for approximately 3 minutes. If after this timed sequence the refrigerator fails to establish a flame, the igniter and solenoid valve will disengage and no longer attempt to light the burner. This condition is referred to as lockout. To let the customer know that the refrigerator has gone into lockout, on the 1st and 2nd generation series models, a red L.E.D. will "flash" on the control strip on refrigerator exterior. On 3rd generation series models an orange flame failure indicator will illuminate to identify this condition. Lighting procedure and flame failure indicators can be reset by making an Off/On procedure.

AES Refrigerator GLOSSARY OF TERMS continued

MAIN SWITCH (1st Generation) - A rotary, two (2) position switch used to complete or interrupt main power circuit to the printed circuit board. This switch utilizes an "OFF" and "ON" position only. With switch turned "ON" the refrigerator will select and operate on the heat source available.

OFF-ON PROCEDURE - Any time the delay cycle is not desired it may be overridden by turning the main switch to the "OFF" position, waiting approximately 5 seconds and then turning the switch back "ON". This procedure cancels the printed circuit board's "memory" and refrigerator will relight on LP gas within a few seconds.



















POLARITY - The property of voltage that causes electrons to flow through a circuit in a certain way. In a 12V DC circuit electrons flow from the negative connection on the battery, through the interconnecting wiring and circuits, then back to the positive connection on the 12V DC battery. Because of this property, to insure proper operation of the refrigerator, the negative lead, from the battery, must be connected to the negative connection on the refrigerator terminal block. The positive lead from the battery must be connected to the positive connection on the terminal block.

PRINTED CIRCUIT BOARD (PCB) - Sometimes called a module board, this device controls many of the operational sequences in the AES refrigerator. The board has three (3) primary functions including:

- A. Controlling all heat sources (120V, 12V & LP gas)
- B. Monitors incoming battery voltage from terminal block
- C. Controls the approximate 25 minute delay cycle from 12V DC operation to LP gas operation.

RELAY, 12V DC - A component controlling the circuit to the 12V DC heating element. Containing a set of normally open contacts, the relay will complete the circuit (by closing contacts) to the heating element when proper voltage is established at the relay. With proper voltage supplied to the relay, an internal coil is energized which closes the contacts to enable 12V DC heating to operate.

SWITCH BOARD (CARD) (2nd Generation) - Similar to the rotary switch found on 1st generation AES models. The circuits are housed on a printed circuit "bread" board that includes a slide switch and two (2) indicator L.E.D.'s. Although appearance and diagnosis of this switch is slightly different from the 1st generation switch, it functions the same in the electrical circuit.

SWITCH/MODE INDICATOR BOARD (3rd Generation) - A more sophisticated version of the switch board. This switch assembly has three (3) separate pushbutton switches as well as the On/Off main slide switch. The three (3) pushbutton switches are marked ,  and . When the main switch is turned on, the 3rd generation refrigerators will automatically select the  mode, operating very similar to the 1st and 2nd generation series. This mode of operation will be indicated by the button illuminating green. If AC and LP gas only is desired, the  pushbutton may be depressed. The  pushbutton will illuminate to indicate this mode selection. If gas only operation is desired, the  pushbutton may be depressed. Regardless of what heat source is available, the refrigerator at this point will only operate on LP gas. Again, the  pushbutton will illuminate to indicate this mode selection. If a flame failure occurs, the L.E.D. assembly will illuminate orange at the lens marked . This assembly also provides useful information to indicate what mode of operation the electronic circuitry has selected. On the switch panel there are four (4) indication lenses marked , ,  and . Whenever it is desired to determine what mode of operation the AES has selected, the small mode indication button  is depressed. While this button is depressed and the AES circuit has selected the 110V AC mode, the  lens will illuminate yellow. If refrigerator has selected 12V DC operation the  lens will illuminate while mode indication is depressed. The  lens will illuminate yellow if system is in the approximate 25 minute delay cycle. Finally, if gas selection has been made, the  lens will illuminate.

TERMINAL BLOCK (MAIN) - The AES utilizes a three (3) section terminal block instead of the two (2) section assembly found on 3-way manually controlled refrigerators. The block houses connections marked positive (+), negative (-) and ignition lock (ign. lock). A wire of proper gauge is connected from the positive lug on the battery to the positive connection on the terminal block. A similar wire, again of proper gauge, is connected from the negative lug on the battery to the negative connection on the terminal block. This gives the printed circuit board a power feed to automatically select the proper heat sources and handles the amperage demands when the refrigerator is operating on 12V DC cooling mode. A minimum 16 gauge wire is connected from the run side of the ignition switch to the ignition lock connection on the terminal block. This wire connection will allow the refrigerator to switch to the 12V DC cooling mode when ignition is turned to the "ON" position. When the ignition key is turned "OFF" (directly after 12V operation) the refrigerator will go into an approximate 25 minute delay cycle (see Delay Cycle).

THERMOCOUPLE - A component connected to solenoid valve, extending above the burner assembly so tip is in the path of flame when refrigerator is operating on LP gas mode. When heat is generated at the tip, the thermocouple will produce a small amount of DC voltage that will keep the solenoid mechanism open to sustain flame. If the flame should blow out and igniter cannot relight flame within a few seconds, the tip of the thermocouple will cool, which will interrupt the production of voltage that, in turn, will allow the mechanism of the solenoid to close. This will prevent LP gas from accumulating at the burner. The thermocouples used will produce from 14 - 30 millivolts DC in normal operation.

AES Refrigerator GLOSSARY OF TERMS continued

THERMO-ELECTRIC SOLENOID VALVE - This device directly replaces the safety valve assembly found on the manually controlled refrigerators. When the AES selects LP gas operation, 12V DC is sent to the solenoid which opens the internal valve. This allows gas to flow onto the test plug and burner assemblies. Once flame is lit, DC millivolts, produced by thermocouple, will keep the valve open. If for any reason the reigniter cannot reestablish flame, the thermocouple will cool which will stop production of DC millivolts. At this time the solenoid valve will close preventing LP gas to accumulate at the burner.

THERMOSTAT - Very similar to electric thermostats found on the manually controlled refrigerator models. This thermostat operates off 12V DC and regulates the inside refrigerator temperature on all heating modes by making and breaking the heat source circuit to the printed circuit board. If thermostat is broken (bellows relaxed) on any AES, the refrigerator will not operate on any heat source.

VENTILATION - One of the three requirements for proper cooling unit operation. The coach vent system must be able to provide a way to direct the hot air produced by the action of the cooling unit out away from the installation of the refrigerator. The refrigerator extracts heat (cooling) from the interior of the refrigerator cabinet and dissipates the heat out through the vent system. The vent area must be free of dead air pockets surrounding the sides and top of the refrigerator to achieve proper air flow. The smaller size refrigerators utilize a double side wall vent system. Where the incoming air is drawn through the lower vent and the heat is dissipated through the upper vent. The larger size refrigerators use a lower side vent and roof vent to accomplish the same venting requirements. The size and placement of each of these vents is critical so it is important to refer to the specific vent requirements outlined in the installation manual when diagnosing vent systems.

VOLTAGE MONITORING 12V DC (PCB) - The printed circuit board has the ability to monitor incoming battery voltage to the terminal block. On the 1st and 2nd generation series models, if battery voltage drops to approximately 9.5V DC (on 120V & LP gas modes only) the printed circuit board will electronically "by-pass" the thermostat circuit causing refrigerator to light on gas and stay on continuously regardless of thermostat knob setting. This is to insure the customer will not lose cooling due to voltage drop. When the voltage drop occurs the green L.E.D. will completely shut off to warn customer of low incoming voltage. Third generation series models have an even more sophisticated 12V DC monitoring system. These models will not engage the 12V DC heating element circuit until 13.3V DC is detected at the terminal block for approximately 40 seconds. If proper voltage (13.3V DC) is not established within 40 seconds the printed circuit board will select LP gas operation. If the 12V DC circuit to the heating element is initially completed but, due to demands of all DC appliances in the R.V., the DC voltage drops to

AES Refrigerator GLOSSARY OF TERMS continued

approximately 11V DC, the refrigerator will disengage the 12V heating element and initiate an approximate delay cycle. (See Delay Cycle). As with the 1st and 2nd generation models, the 3rd generation models will stay lit continuously on LP gas mode if voltage drops to approximately 9.5V DC. At this time the mode switch lamp will shut off to let the customer know DC voltage is low.

WIRE GAUGE (Size) - A standardized method of rating the size of wire diameter. In electrical appliances the size of wire is a necessary consideration so the circuits do not experience voltage losses and the wire can handle the amperage demands of the electrical components. A small gauge wire cannot safely handle the same amperage loads with a voltage drop that a larger gauge wire can. The smaller the gauge of wire, the larger is its numeral value; the larger the gauge of wire, the smaller is its numerical value. For the refrigerator to operate properly on all modes of heat, refer to wiring size chart to insure the proper size wire has been used in the installation (see page A-6-26).

AES Refrigerator

CONTINUITY READINGS FOR SWITCH CARD & HARNESS

Model 3801

The following is a list of checks that should be made on the switch card and harness assembly before replacing the switch card or wiring harness. These checks are to be done with wiring harness REMOVED from the printed circuit board.

1. ON-OFF SWITCH

- A. With the switch in the "ON" position, continuity should be indicated between the yellow terminal on the 10 pin connector to the orange terminal on the 10 pin connector.
- B. With the switch in the "OFF" position, no continuity should be indicated between the yellow terminal on the 10 pin connector to the orange terminal on the 10 pin connector.
- C. With the switch in the "OFF" position, continuity should be indicated between the red terminal on the 10 pin connector to the orange terminal on the 10 pin connector.
- D. With the switch in the "ON" position, no continuity should be indicated between the red terminal on the 10 pin connector to the orange terminal on the 10 pin connector.

2. AES FUNCTION SWITCH

- A. With the AES function switch manually depressed, continuity should be indicated between the blue terminal on the 7 pin connector to the black terminal on the 7 pin connector.
- B. With the AES function switch NOT depressed, no continuity should be indicated between the blue terminal on the 7 pin connector to the black terminal on the 7 pin connector.

3. AES FUNCTION LAMP

- A. Measure resistance between the brown terminal on the 10 pin connector to the brown terminal on the 7 pin connector. The proper resistance is approximately 65,000 OHMs.

4. AC/GAS FUNCTION SWITCH

- A. With the AC/GAS function switch manually depressed, continuity should be indicated between the blue terminal on the 10 pin connector to the orange terminal on the 10 pin connector.
- B. With the AC/GAS function switch NOT depressed, no continuity should be indicated between the blue terminal on the 10 pin connector to the orange terminal on the 10 pin connector.

AES Refrigerator CONTINUITY READINGS FOR SWITCH CARD & HARNESS continued

5. AC/GAS FUNCTION LAMP

Measure resistance between the brown terminal on the 10 pin connector to the gray terminal on the 10 pin connector. The proper resistance is approximately **65,000** OHMs.

6. GAS FUNCTION SWITCH

A. With the gas function switch manually depressed, continuity should be indicated between the violet terminal on the 10 pin connector to the orange terminal on the 10 pin connector.

B. With the gas function switch NOT depressed, no continuity should be indicated between the violet terminal on the 10 pin connector to the orange terminal on the 10 pin connector.

7. GAS FUNCTION LAMP

Measure the resistance between the brown terminal on the 10 pin connector to white terminal on the 10 pin connector. The proper resistance is approximately 65,000 OHMS.

8. 120V MODE LAMP SWITCH

A. With the mode switch (?) manually depressed, resistance should be indicated between the brown terminal on the 10 pin connector to the red terminal on the 7 pin connector. The proper resistance is approximately 2 1,000 OHMs.

B. With the mode switch NOT depressed, no resistance should be indicated between the brown terminal on the 10 pin connector to the red terminal on the 7 pin connector.

9. 12V MODE LAMP AND SWITCH

A. With the mode switch manually depressed, resistance should be indicated between the brown terminal on the 10 pin connector to the orange terminal on the 7 pin connector. The proper resistance is approximately 2 1,000 OHMs.

B. With the mode switch NOT depressed, no resistance should be indicated between the brown terminal on the 10 pin connector to the orange terminal on the 7 pin connector.

AES Refrigerator CONTINUITY READINGS FOR SWITCH CARD & HARNESS continued

IO. DELAY MODE LAMP AND SWITCH

- A. With the mode switch manually depressed, resistance should be indicated between the brown terminal on the 10 pin connector to the yellow terminal on the 7 pin connector. The proper resistance is approximately 2 1,000 OHMs.

- B. With the mode switch NOT depressed, no resistance should be indicated between the brown terminal on the 10 pin connector to the yellow terminal on the 7 pin connector.

II. GAS MODEL LAMP AND SWITCH

- A. With the mode switch manually depressed, resistance should be indicated between the brown terminal on the 10 pin connector to the green terminal on the 7 pin connector. The proper resistance is approximately 21,000 OHMs.

- B. With the mode switch NOT depressed, no resistance should be indicated between the brown terminal on the 10 pin connector to the green terminal on the 7 pin connector.

12. GAS FLAME WARNING LAMP

Measure resistance between the brown terminal on the 10 pin connector to black terminal on the 10 pin connector. The proper resistance is approximately 21,000 OHMs.

NOTE: In normal operation, the gas flame warning lamp will illuminate if the refrigerator fails to light after approximately 3 minutes. This lamp, however, will illuminate within approximately 10 seconds if the refrigerator fails to spark in the gas mode.

Model 2802

The following is a list of checks that should be made on the switch card and harness assembly before replacing the switch card or wiring harness. These checks are to be done with the wiring harness REMOVED from the printed circuit board.

1. ON-OFF SWITCH

- A. With the switch in the "ON" position, continuity should be indicated between the yellow terminal on the 10 pin connector to the orange terminal on the 10 pin connector.
- B. With the switch in the "OFF" position, NO should be indicated between the yellow terminal on the 10 pin connector to the orange terminal on the 10 pin connector.
- C. With the switch in the "OFF" position, continuity should be indicated between the red terminal on the 10 pin connector to the orange terminal on the 10 pin connector.
- D. With the switch in the "ON" position, no continuity should be indicated between the red terminal on the 10 pin connector to the orange terminal on the 10 pin connector.

2. AC/GAS FUNCTION SWITCH

- A. With the AC/GAS function switch manually depressed, continuity should be indicated between the blue terminal on the 10 pin connector to the orange terminal on the 10 pin connector.
- B. With the AC/GAS function switch NOT depressed, no continuity should be indicated between the blue terminal on the 10 pin connector to the orange terminal on the 10 pin connector.

3. AC/GAS FUNCTION LAMP

Measure resistance between the brown terminal on the 10 pin connector to the gray terminal on the 10 pin connector. The proper resistance is approximately 65,000 OHMS.

4. GAS FUNCTION SWITCH

- A. With the gas function switch manually depressed, continuity should be indicated between the violet terminal on the 10 pin connector to the orange terminal on the 10 pin connector.

AES Refrigerator **CONTINUITY READINGS FOR SWITCH CARD & HARNESS** continued

- B. With the gas function switch NOT depressed, no continuity should be indicated between the violet terminal on the 10 pin connector to the orange terminal on the 10 pin connector.

5. **GAS FUNCTION LAMP**

Measure resistance between the brown terminal on the 10 pin connector to white terminal on the 10 pin connector. The proper resistance is approximately 65,000 OHMs.

6. **GAS FLAME WARNING LAMP**

Measure resistance between the brown terminal on the 10 pin connector to the black terminal on the 10 pin connector. The proper resistance is approximately 2 1,000 OHMs.

NOTE Normal operation the gas flame warning lamp will illuminate if the refrigerator fails to light after approximately 3 minutes. This lamp, however, will illuminate within approximately 10 seconds if the refrigerator fails to spark in the gas mode.



BULLETIN #46

Rev. September 1986

Operation of the AES System (Automatic Energy Selector)

The control system on the AES selects the most suitable energy source. The selection will be made with highest priority to 120 volt, second priority to 12 volt from the alternator (if 12V DC is provided to the ignition lock terminal from the vehicle ignition switch) and lowest priority to gas operation. There are only two customer controls to operate the system; the thermostat and the on-off switch. When the switch is turned on, a green indicator light glows to show that the system has 12 volts supplied. This indicator light will flash red on the gas mode, if the propane burner fails to light.

The AES has a built-in safety device that delays gas ignition and start up approximately 20 minutes from 12 volt operation. This enables the customer to stop and refuel the vehicle without touching the refrigerator. If the delay is not desired after stopping, the system may be re-set by switching the main switch off and then back on.

SAFETY DEVICE

The AES system also has a built-in safety device that will prevent operation, if one of the following parts breaks down: A. the **printed circuit board**, B. the **igniter** or, C. there is no **control voltage to the terminal block**. This feature ensures that the thermo-electric solenoid valve will not open as the result of a part failure.

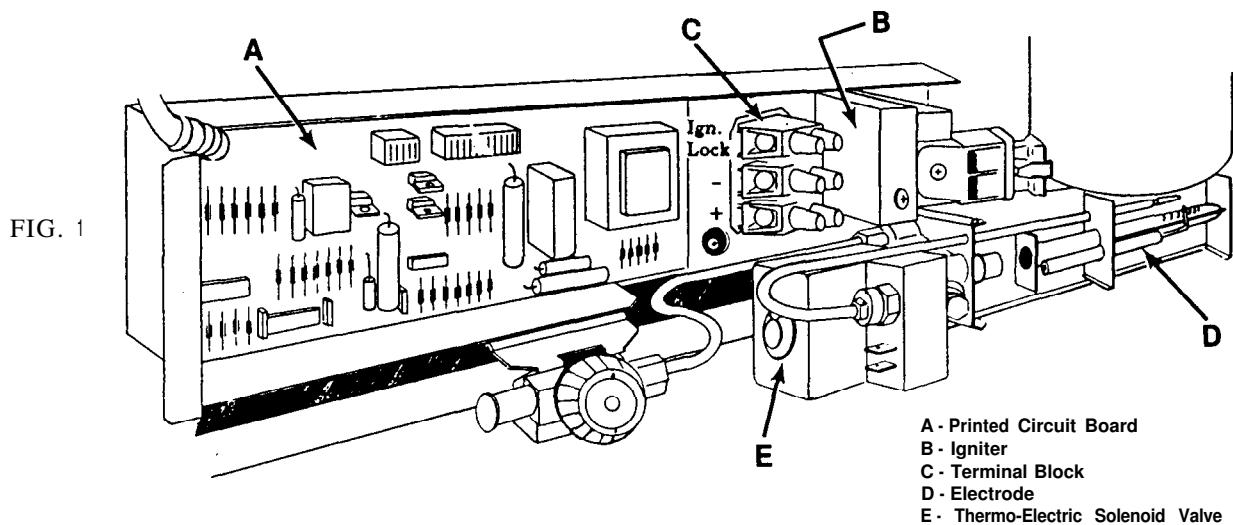

PART EXPLANATION AND TROUBLESHOOTING DIAGNOSIS

PRINTED CIRCUIT BOARD

The printed circuit board is the heart of the AES. From this point, all the energy sources are controlled, including the gas start-up delay from 12 volt operation. The 120 volt operation is not affected by the 12 volt delay feature. Anytime the system receives 120 volts, the refrigerator will switch over to the 120 volt electric mode. It should be noted, however, if the 120 volt supply is disconnected within the 20 minute delay cycle, a gas start-up will not occur until the end of the delay period. As before, if a delay is not desired, the refrigerator may be re-set by making an off-on procedure. A normal gas start-up will then occur.

The circuit board on the AES also has the ability to monitor the 12 volt supply voltage. If the incoming voltage to the refrigerator drops below 9.5 (+ 1) volts, the AES will switch to gas operation and the refrigerator will be unaffected by the thermostat. Until the low voltage situation is corrected, the system will remain on gas continually and will not switch to 120 or 12 volt and overcooling or freezing will probably occur. As a warning device, the green indicator light will shut off during the voltage drop. When the incoming voltage returns to 12 volts, the green indicator lamp will switch back on and the refrigerator will again return to the most suitable energy source. It must be remembered that the AES requires 12 volts at all times to operate on 120 volts, 12 volt or gas.

When a problem with the refrigerator system is being diagnosed and it is suspected that the circuit board is at fault, most likely the failure will be visible on the board itself. If the AES fails to operate and it is noted that there is a shorted wire between diodes or a shorted or burned section of the connecting foil on the circuit board, it is probable that this circuit board is defective. Be sure the troubleshooting steps outlined below are followed BEFORE changing the board. The AES Analyzer (Part #800-0006-00/0) also may be used to test the printed circuit boards.

HEATERS

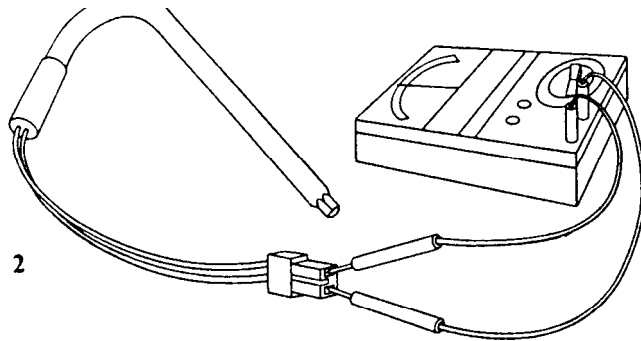

FIG. 2

MODEL	OHM'S READING
3800 & 1303 AES	42 Ohm's
3600 & 763	54 Ohm's
3500 & 663 AES	82 Ohm's

The 120 and 12 volt heaters that are included in the AES refrigerator contain a quick connect contact plug - for ease of replacement. These plugs are polarized and will fit only one way. When checking the electric element, you should notice a 42 ohm's reading with the 3800 and 1303 AES; 54 ohms on the 3600 and 763; and 82 ohms on the 3500 and 663 AES. With these models on 12V operation, the heaters will draw 22.9, 20.8 and 15.8 amps respectively.

SOLENOID VALVE

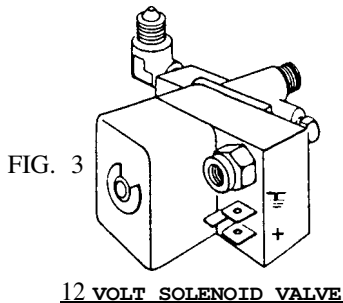

FIG. 3

The AES uses a thermo-electric solenoid valve for opening and closing the gas supply line instead of the usual manually operated safety valve. When the refrigerator is ready to light on gas, the circuit board will send 12 volts to the solenoid valve to open it. After the flame is lit the millivolts supplied from the thermocouple will keep the solenoid valve open. The 12 volt signal current from the circuit board will drop off in 10-20 seconds after the flame is lit. To check the valve for operation, disconnect the braided cable plug from the solenoid valve. Connect a jumper wire from the 12 volt positive terminal on the refrigerator to the lower lug on the solenoid valve. When this is done, an audible click should be heard. This

indicates that the valve is operational. The solenoid valve should be replaced if it does not click open. If the valve opens, the D.C. voltage from the igniter must be checked. To open the solenoid valve, there must be a positive pulse voltage between the yellow wire on the igniter (marked L) and ground. This pulse voltage is supplied by the igniter. It should be noted that the resistance cannot be checked across the terminals ~~W~~ the solenoid valve without damaging the circuit board if the braided cable is connected.

THERMOSTAT

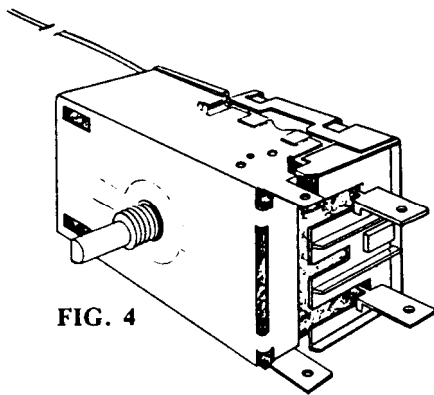

FIG. 4

The thermostat used in the AES system is a normal electric thermostat without an off position. It operates on low voltage from the printed circuit board. If the thermostat is broken and has lost its charge, the refrigerator will not operate on gas, 120 or on 12 volt. If it is believed that the thermostat is broken, by-pass the thermostat by removing the two wires connected to it. Then place the two leads from the thermostat together and try for operation. The thermostat should be replaced if the refrigerator now functions properly when the leads are connected.

Overfreezing will occur in the refrigerator if the thermostat capillary tube is not far enough into its holder. For the Model 1303 AES, the capillary tube distance should be 35" to 36" from the tip of the sensing tube to the bottom of its holder; and on the Model 763 AES, it should be 31" to 32". For the new style thermostat, Part No. / 9 AES, the capillary tube attaches to the evaporator on models 3800, 3600, 3500 and 663 ONLY.

IGNITER

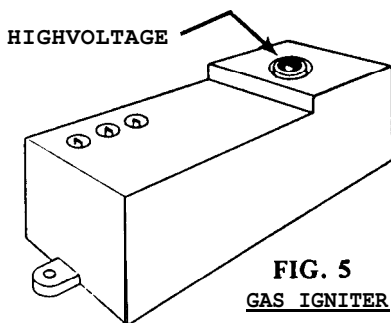

FIG. 5
GAS IGNITER

The igniter operates with 12 volt current. On gas operation the igniter senses the resistance through the flame between the electrode and burner. When there is no flame at the burner, the resistance is high and the igniter begins sparking to light the burner. As soon as the flame is lit, the resistance between the electrode and burner drops and the igniter stops sparking. The resistance is monitored by the igniter and if for any reason the flame goes out, the igniter begins sparking until the burner is lit. This insures that the flame will always be lit when desired.

If the electrode does not spark, first make sure the igniter is receiving 12 volts. If the igniter is receiving 12 volts and produces no spark, it must be checked for operation. Remove the wire between the electrode and igniter and place 12 volts at the 12 volt + lug. If no internal clicking sound is heard, the igniter is broken. It is important to remove the high voltage wire that goes to the electrode from the igniter when you are checking the igniter for operation. The high voltage wire and the electrode can be connected to ground causing the circuit board to think that the flame is lit, resulting in no spark on gas operation. Moisture or dirt on the electrode itself will also affect the igniter. When diagnosing an igniter problem double check it to make sure the igniter is dry, clean and has proper gap (see FIG. 7).

INDICATION LAMPS

The indication lamp consists of two light emitting diodes; one green and one red. When the 12 volt supply to the refrigerator is adequate to operate the system, the green light shows. If the system runs out of propane fuel, the indicator light flashes red to warn you that the gas supply is depleted. If the battery voltage drops below 9.5 (& 1) volts, the green indicator light will shut off to warn you of the low battery condition. At this time, the flame will be continuously lit until the battery returns to 12 volts. It also must be remembered that all electrical connections in the AES are polarized, including the indicator lights. This light will show constant red and flashing green if it is inserted upside down on the 1303, 763 and 663.

MAIN SWITCH

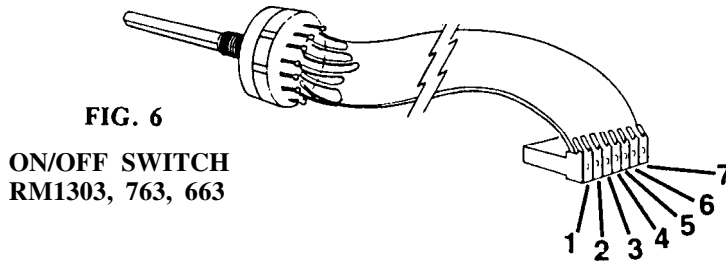

FIG. 6

**ON/OFF SWITCH
RM1303, 763, 663**

Models 1303, 763 663:

The switch operates on 12 volts from the circuit board. In normal operation, the switch should travel only to the ON and OFF positions. A switch that travels more than this has been installed incorrectly or the installation nut that holds the switch in place has worked loose. If the switch is the suspected point of failure, check the connecting ribbon cable for visible cuts or shorts. The switch can be checked for continuity between terminals 1 and 2, 4 and 5, 6 and 7 in the "ON" position; and 2 and 3, 5 and 7 in the "OFF" position. Remember to disconnect the switch from the AES circuit board when checking for continuity.

Models 3800, 3600 3500:

Check for continuity only between terminals 1 and 2, 3 and 4, 5 and 10 using the low scale (RX-1) on an ohm meter, with the switch in the ON position and continuity only between terminals 1 and 3, 5 and 6 in the OFF position. Also, be sure to disconnect from the AES circuit board and check continuity from the plug at the AES circuit board end. This will check the ribbon cable as well as the switch.

ELECTRODE

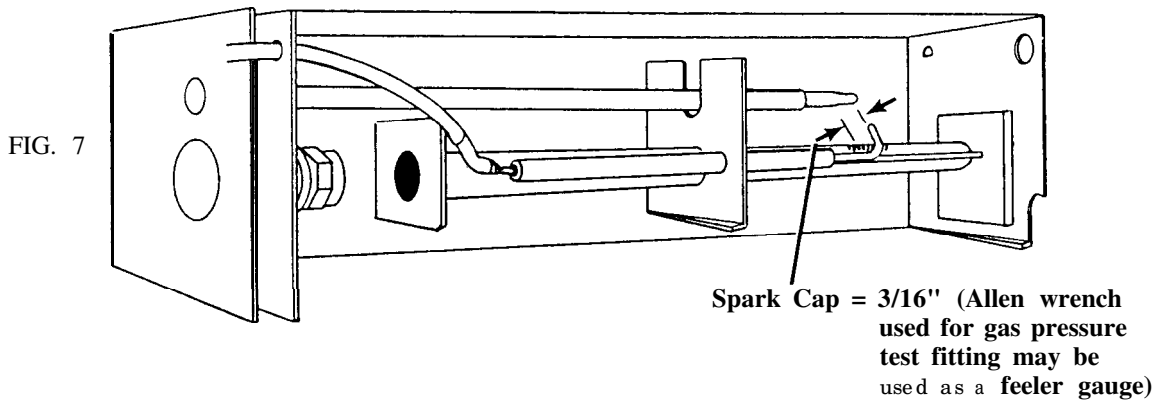

FIG. 7

**Spark Cap = 3/16" (Allen wrench
used for gas pressure
test fitting may be
used as a feeler gauge)**

The electrode serves two basic functions on the AES refrigerator. It is used as a contact point to transmit the spark from the igniter to the burner. The electrode also acts to measure the resistance between it and the burner and sends this information to the igniter module. When the resistance is high, the igniter starts sparking and when it is low the igniter stops sparking. Because of this, the electrode position is extremely important. If the electrode is too close to the burner the resistance is low and the system will think the burner is lit - especially true with high humidity. In this situation, no spark will occur. Some atmospheric conditions such as very high humidity and/or coastal salt air may necessitate a wider than minimum gap; therefore, the optimum gap should be 3/16" or 5 mm. If the gap from the electrode to the burner is too large, the resistance will be too high and the igniter will continue to spark even though the flame is lit. With this situation, the flashing red indicator light will come on in approximately 3 minutes.

In closing, there are two more external parts that can cause problems with your AES refrigerator. First, if your propane supply to your refrigerator is depleted, no cooling on gas will take place and the red indicator light will flash. When it is noticed that the indicator light is flashing red, always check your fuel supply first. The second external part that may be causing the problem with the control system is the 12 volt battery. If a weak or dead battery is used to operate the refrigerator, the AES controls will not function properly. No cooling or bad cooling on gas, electric and 12 volt will occur, if the battery is discharged or shorted. If the battery drops below 9.5 (+ 1) volts, the refrigerator will only be operational on gas. It has also been noted that the AES will often overcool with a weak battery in line. No indicator or interior light and no control functions indicate a weak or dead battery. Remember, without a constant 12 volt source to the refrigerator, the system will not work on 120 or 12 volt or on gas.

Some corrosion on the circuit boards resulting in malfunctions have been caused by water or car wash solution being sprayed onto the back of the refrigerator through the side vent door louvers. Sealing the circuit board enclosure should prevent recurrence; however, the owner should be made aware of this situation.

If you run into any problems that are not addressed here, please contact our Technical Services Department available to all Dealers, Service Centers and OEM' s.

AES REFRIGERATOR WIRING DIAGRAMS

RM6 3

2930371 II

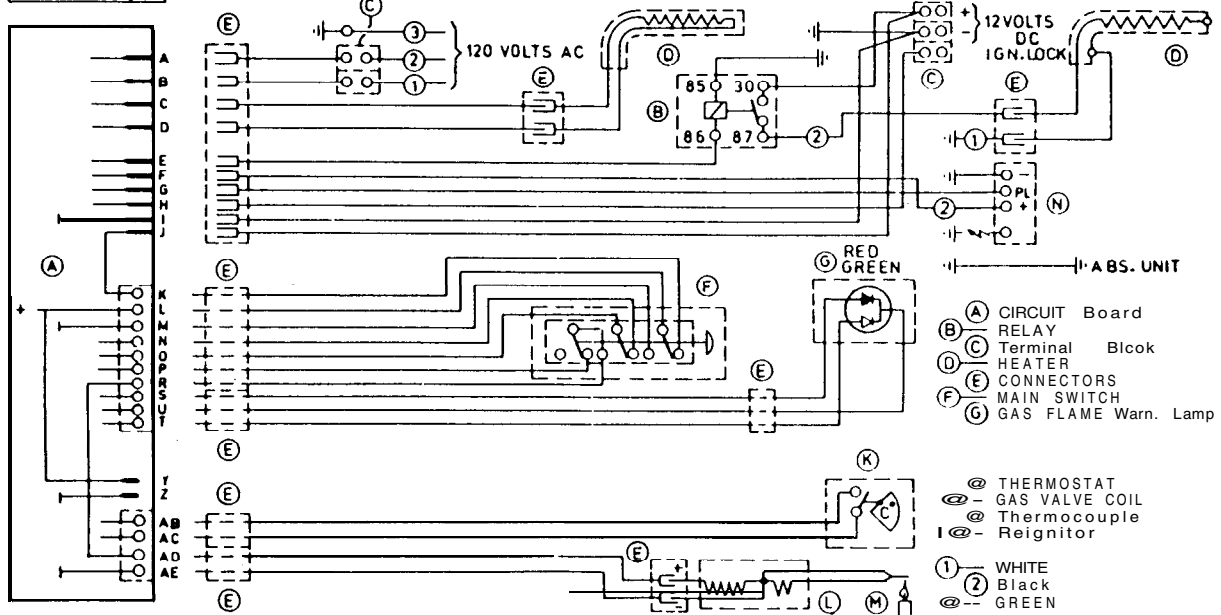

RM763

2930372 II

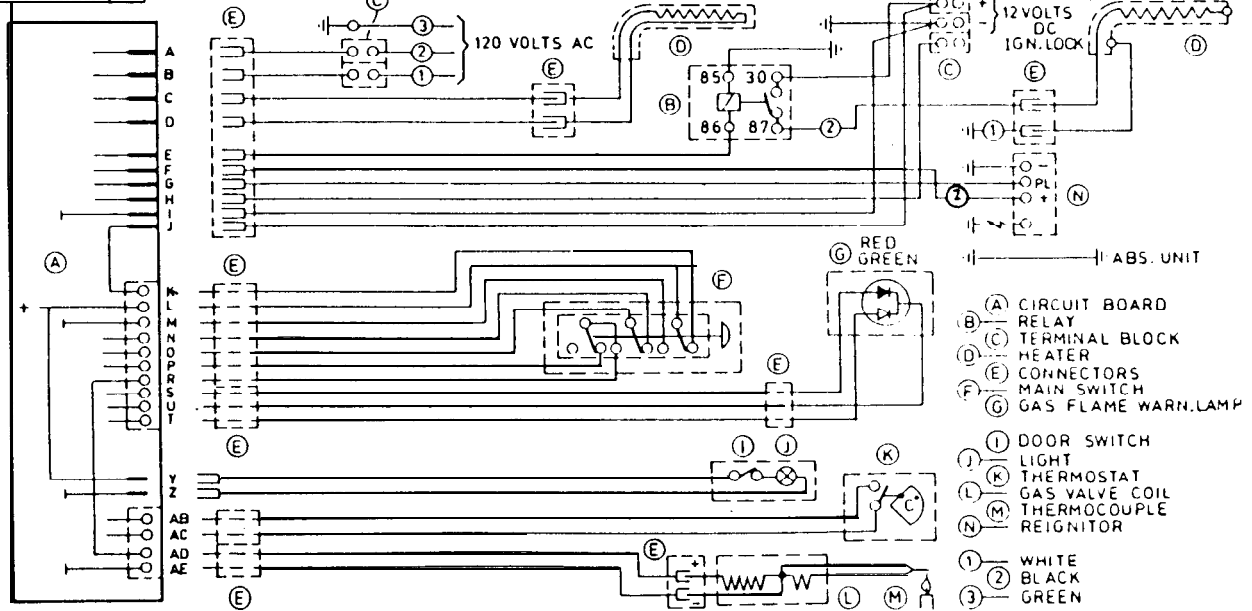

AES REFRIGERATOR WIRING DIAGRAMS

RM1303

2930372 I

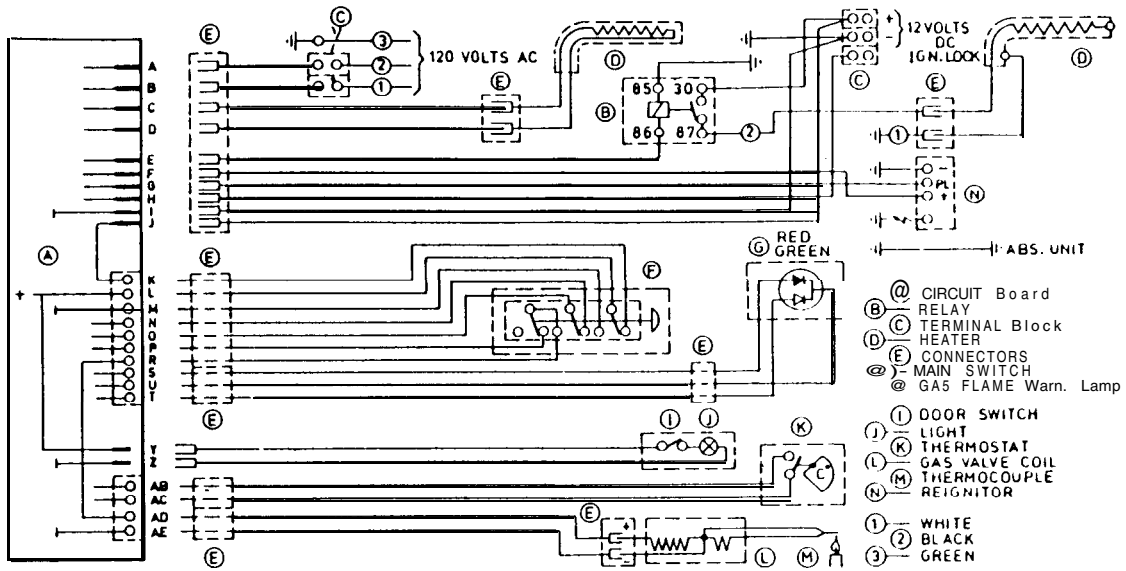

RM3500 - RM3600 - RM3800

2930797

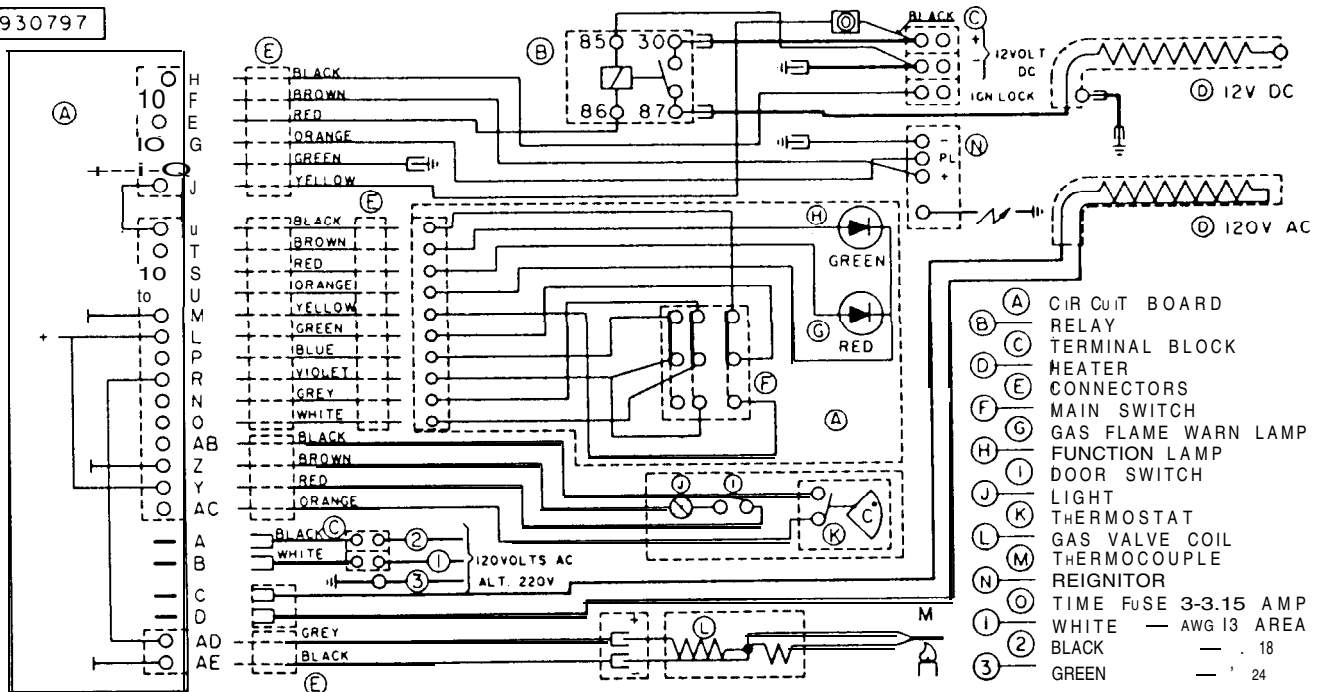

CIRCUIT BOARD DIAGNOSIS

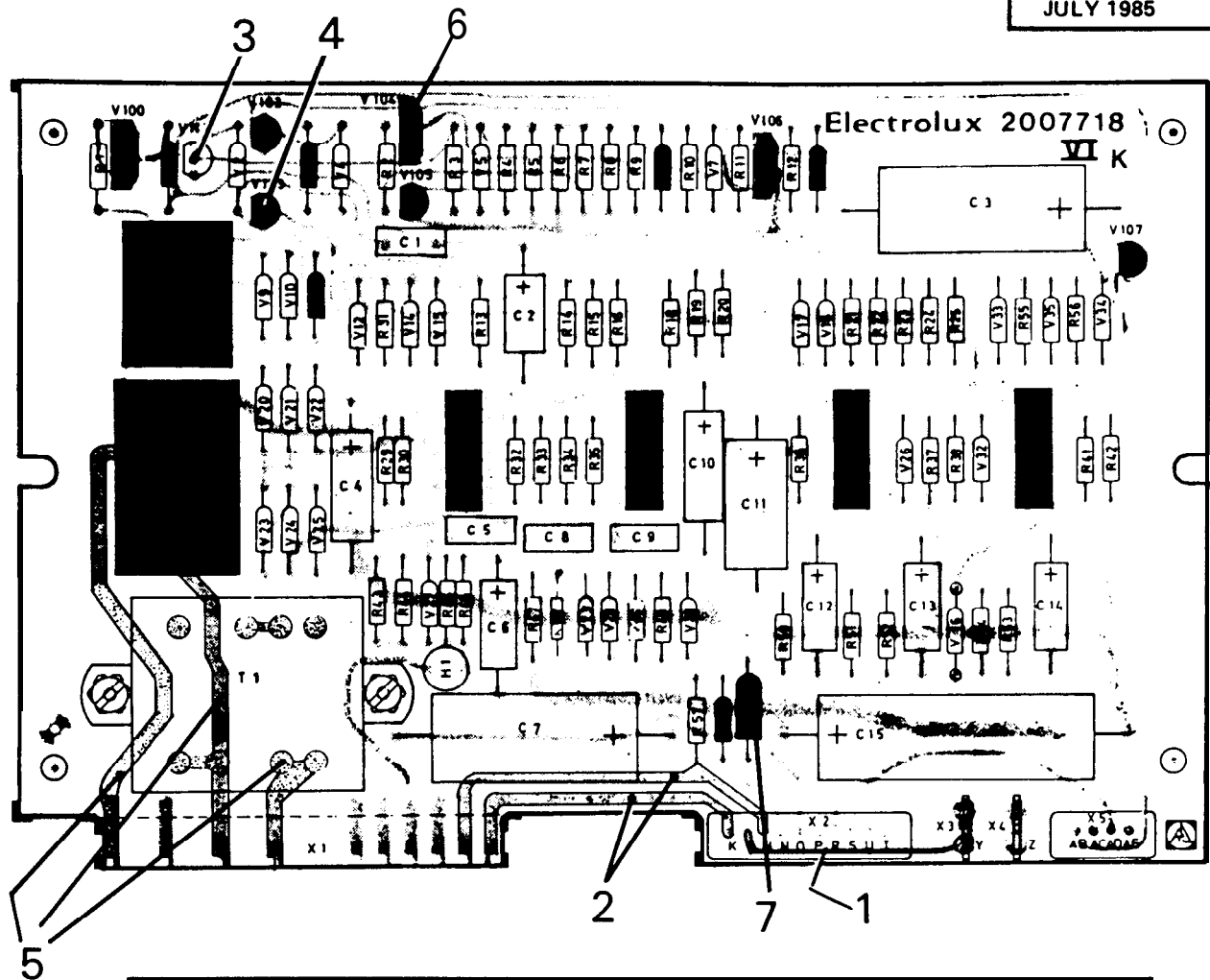
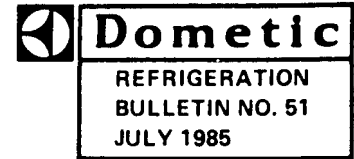

1.	IF THIS LEAD IS DAMAGED:	LOOK FOR A SHORT CIRCUIT OR DAMAGE IN THE INTERIOR LIGHT CABLE.
2.	IF THIS LEAD IS DAMAGED:	LOOK FOR A SHORT CIRCUIT OR DAMAGE IN THE RIBBON CABLE TO THE MAIN SWITCH AND THERMOSTAT.
3.	IF THIS COMPONENT IS DIS-COLORED, BURNED OR BLOWN:	CHECK ALL CABLES IN THE 12 VOLT SYSTEM FOR SHORT CIRCUITS.
4.	IF THIS COMPONENT IS DIS-COLORED, BURNED OR BLOWN:	CHECK THAT THE 12 VOLT CONNECTIONS ARE CORRECT AND THAT THERE IS A BATTERY BETWEEN ALTERNATOR AND REFRIGERATOR.
5.	IF THIS LEAD(S) IS DAMAGED:	CHECK FOR PROPER RESISTANCE IN OHM'S OF THE A/C HEATING ELEMENT AND ALL 120 VOLT CABLES FOR SHORT CIRCUIT OR DAMAGE.
6.	IF THIS COMPONENT IS DIS-COLORED, BURNED OR BLOWN:	CHECK FOR PROPER POLARITY OF GAS SOLENOID LEAD.
7.	IF THIS COMPONENT IS DIS-COLORED, BURNED OR BLOWN:	CHECK FOR PROPER PLUG CONNECTIONS OF GAS SOLENOID AND THERMOSTAT ON CIRCUIT BOARD. CHECK FOR SHORT CIRCUIT OR DAMAGE IN RIBBON CABLE TO INDICATOR LIGHT, THERMOSTAT.

AUTOMATIC ENERGY SELECTOR

Our technicians continue to get calls from the field regarding the flashing red light on the A.E.S. Refrigerators indicating a lack of understanding.

There can be times when the red light may flash, but there is nothing that has malfunctioned in the refrigerator. In order to help our customers make that determination, the following sequence is suggested.

1. Turn knob "A" (Main Switch) to position OFF. Wait 5 seconds and turn back to ON. The indicator light "E" should go to green and the control system will begin a new sequence. If the refrigerator has not been in operation for a while or the gas bottles have just been refilled, this operation may have to be repeated several times to clear air from the gas line. (Each gas starting sequence will last for about 3 minutes).

2. If the above question is not successful, check your gas supply, make sure that ALL gas valves between the refrigerator and the gas bottles have been opened. Don't overlook the gas shut off valve 'a' in the back of the refrigerator.

3. Make sure the R.V. Battery is not discharged as the refrigerator can not function properly if the 12 Volt D.C. power is low.

4. If none of the above operations are successful, advise the customer to bring the unit in for diagnosis.

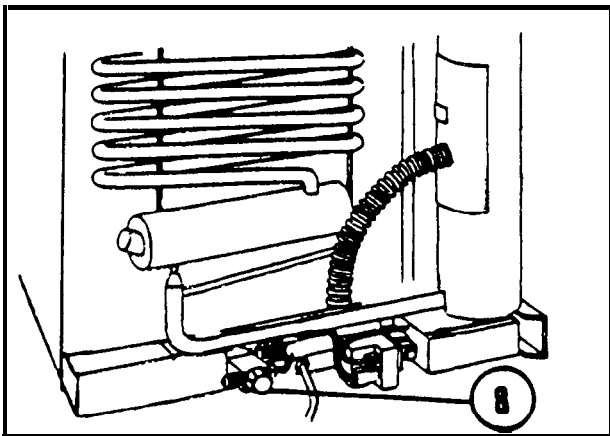

FIGURE A

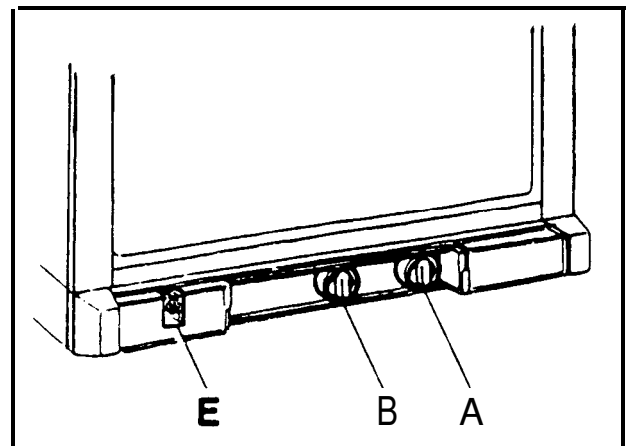

FIGURE B

RE: Page 7, DSC #304, Installation and Operating Instructions, AES Refrigerators

Replacement of Circuit Boards

Dometic
REFRIGERATOR
BULLETIN R56/7A
June, 1987

3-WAY AES CIRCUIT BOARDS

RM3500, 3600, 3800

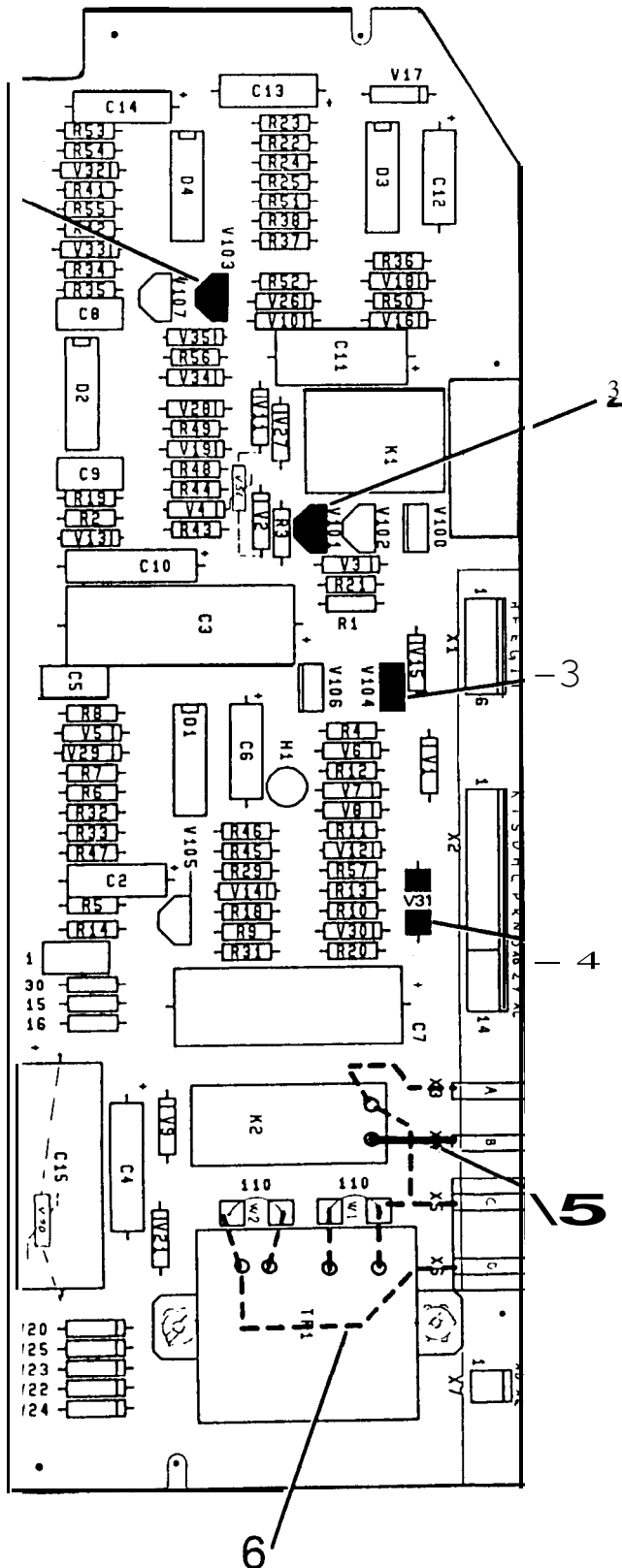

When working on an AES style refrigerator and replacing the circuit board, the old board should be visually inspected for any obvious damage, i.e. burned components, damaged leads, burned connectors, corrosion, etc.

When the board is damaged, see the illustration to the left for what to check and correct before changing the circuit board.

The following paragraph numbers relate to the corresponding numbered items highlighted at the circuit board.

1. If this component is discolored, burned or blown: Check that the 12V connections are correct and that there is a battery between alternator and refrigerator.
2. If this component is discolored, burned or blown: Check all cables in the 12V system for short circuits.
3. If this component is discolored, burned or blown: Check for proper polarity of gas solenoid lead.
4. If this component is discolored, burned or blown: Check for proper plug connections of gas solenoid and thermostat circuit or damage in ribbon cable to indicator light, thermostat.
5. If this lead is damaged: Check for proper resistance in Ohm's of the A/C heating element and in all 120V cables for short circuit or damage.
6. If these leads (dotted in the picture) at the rear of the board are damaged: Check for proper resistance in Ohm's of the A/C heating element and all 120V cables for short circuit or damage.

3-WAY AES CIRCUIT BOARDS RM3501, 3601, 3801, 4801

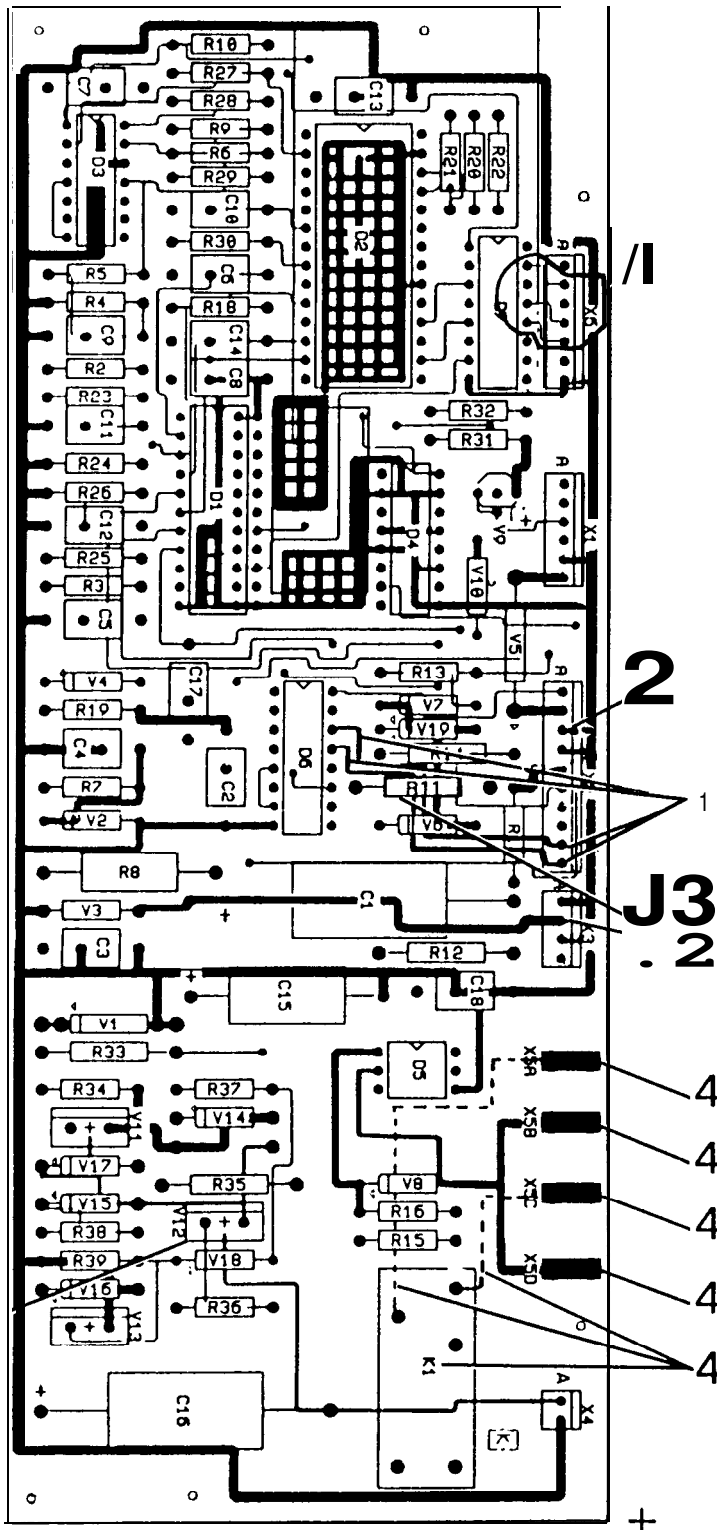

Check the old circuit board before installing a new one. If damages as shown below are found, the defects causing the circuit board breakdown **must be corrected before the new one is installed.**

The following paragraph numbers relate to the corresponding numbered items highlighted at the circuit board.

1. If these areas are burned, the lead between the circuit board and the control circuit board must **be checked** for short circuits.
2. If soldering at board rear is burned, the interior light lead is likely to be shorted to ground.
3. If RI1 is blown the "Ignition Lock" voltage has been too high (over 12V DC f 10%).
4. If X5A, X5B, X5C, X5D and/or K1 are burned (either side of the board), the AC voltage has been too high (over 120V AC + 10%). Also check the heater in this case.
5. If V12 is burned, the solenoid leads can be reversed.

2-WAY AES CIRCUIT BOARDS RM2602 AND RM2802

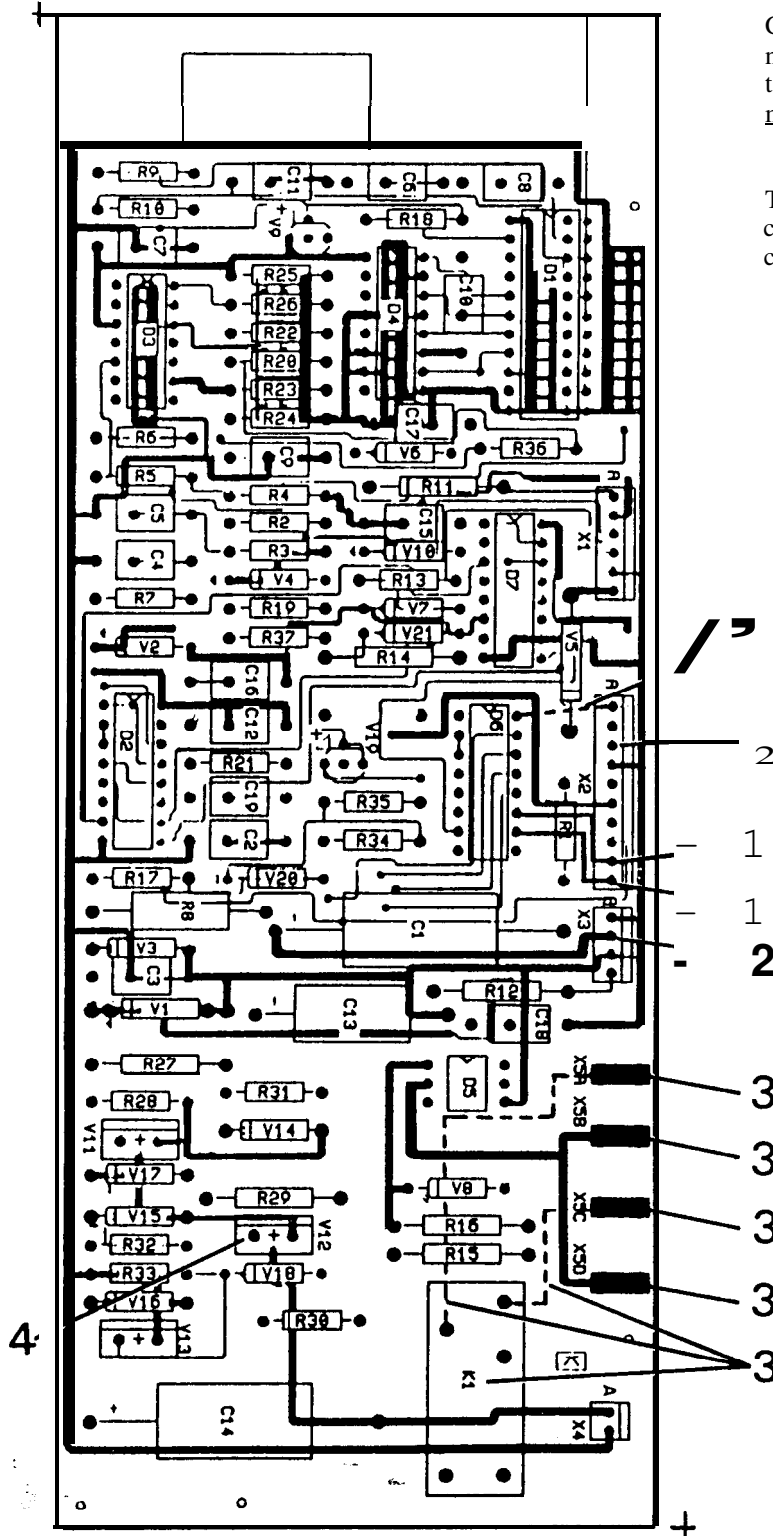

Check the old circuit board before installing a new one. If damages as shown below are found, the defects causing the circuit board breakdown must be corrected before the new one is installed.

The following paragraph numbers relate to the corresponding numbered items highlighted at the circuit board.

1. If this area is burned, the lead between the circuit board and the control circuit board must be checked for short circuits.
2. If soldering at board rear is burned, the interior light lead is likely to be shorted to ground.
3. If X5A, X5B, X5C, and/or K1 are burned (either side of the board), the AC voltage has been too high (over 120V AC +10%). Also check the heater in this case.
4. If V12 is burned, the solenoid leads can be reversed.

REPLACEMENT OF CIRCUIT BOARDS

Models: RM663 RM763 RM1303

When replacing the circuit board in the 663, 763 and 1303, you MUST, upon inspection of the board, install the 12 Volt DC fuse provided. See Item #2, Page 2.

1. When working on an AES style refrigerator and replacing the circuit board, the old board should be visually inspected for any obvious damage, i.e. burnt components, damaged leads, burnt connectors, corrosion, etc.
 - a. When the board is damaged, see the following illustrations for what to check and correct before changing the circuit board:

FIG. 1

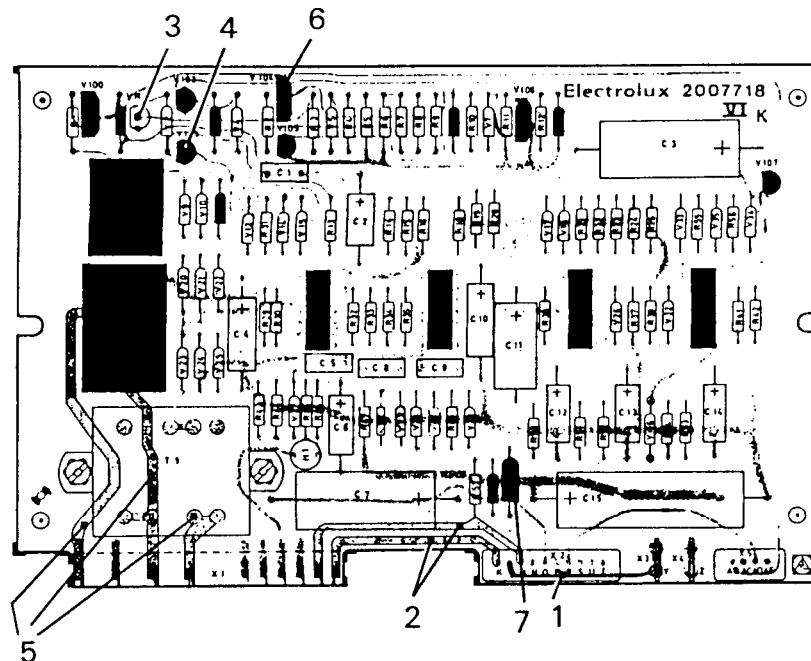

The following paragraph numbers relate to the same indicator numbers at the circuit board designations.

- | | |
|---|--|
| <ol style="list-style-type: none"> 1. If this lead is damaged: Look for a short circuit or damage in the interior light cable. 2. If this lead is damaged: Look for a short circuit or damage in the ribbon cable to the main switch and thermostat. 3. If this component is discolored, burned or blown: Check all cables in the 12 volt system for short circuits. 4. If this component is discolored, burned or blown: Check that the 12 volt connections are correct and that there is a battery between alternator and refrigerator. | <ol style="list-style-type: none"> 5. If this lead(s) is damaged: Check for proper resistance in Ohm's of the A/C heating element and all 120 volt cables for short circuit or damage. 6. If this component is discolored, burned or blown: Check for proper polarity of gas solenoid lead. 7. If this component is discolored, burned or blown: Check for proper plug connections of gas solenoid and thermostat on circuit board. Check for short circuit or damage in ribbon cable to indicator light, thermostat. |
|---|--|

- b. Verify that the positive (+) 12V. DC wire going to the circuit board is connected directly to the coach battery positive (+) terminal.

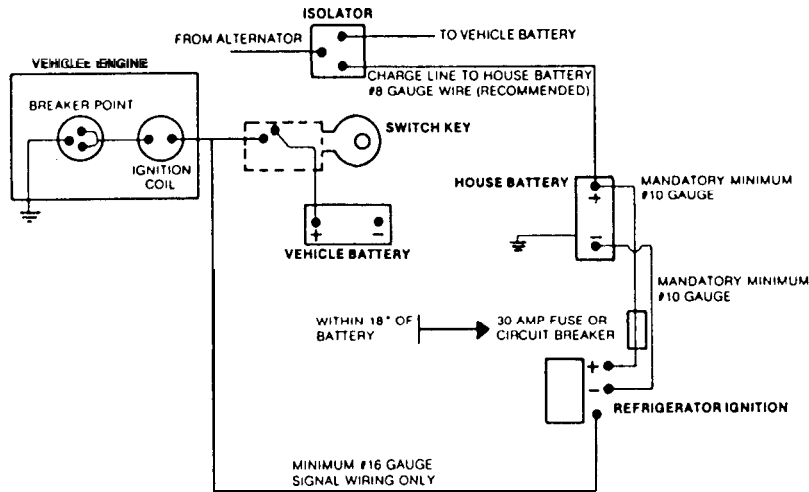

2. The electrical system should also be checked to assure the 12V. DC circuit has been fused; if not, see the following procedure:

Install the 12V. DC in-line fuse holder before the circuit board as shown in the illustration. One-quarter of an hour labor is authorized to install the fuse along with the standard time approved to install the circuit board.

FIG. 3

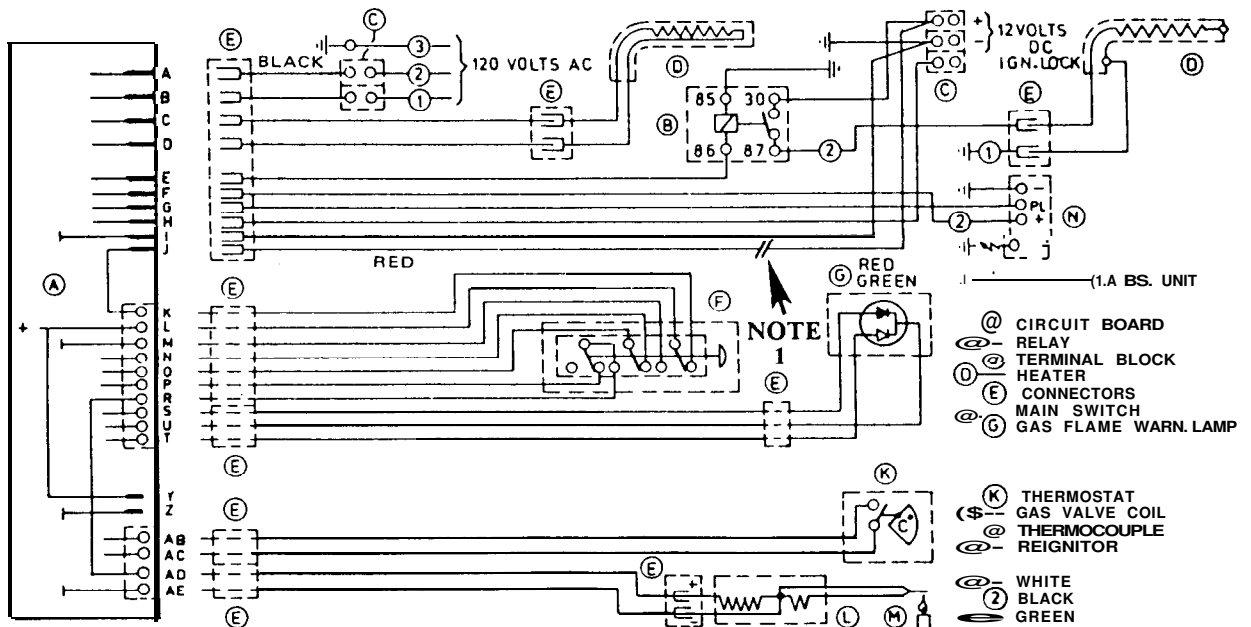

NOTE:

- (1) Install the 3.5 Amp fuse here for the 12V. DC line protection.



Lastly, the moisture shield kit has been enclosed and can be installed to prevent corrosion damage caused by water or car wash solution being sprayed into the back of the refrigerator through the vent louvers. The circuit board compartment should be sealed in the following manner:

- a. Install the shield under the bottom mounting bracket of the cooling unit. See the drawing below by model number. Seal the top edge with the foil tape supplied.
- b. Seal around the conduit, where it goes into the circuit board compartment, with putty tape supplied or a silicon sealant can be used.

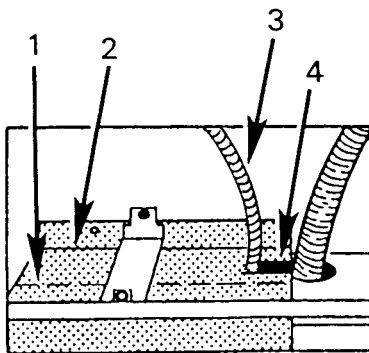
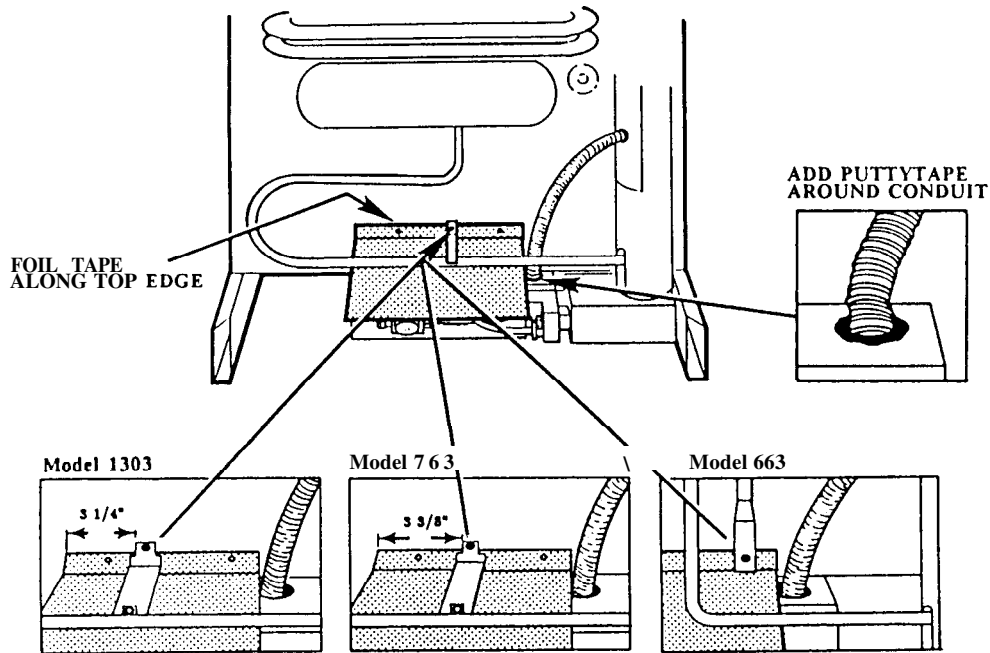

NOTE: The early series only which has the rectangular boiler enclosure, requires that the shield be bent across the middle slightly (1), with a little more angle on the upper tab (2).

Models with the interior light conduit (3) coming out of the top of the circuit board housing may require a trimmed slot and putty tape around the conduit and slot.

Caution should be used when washing the vehicle and avoid spraying water onto the refrigerator.

AES MODELS RM3601 3801 MODULEBOARD REPLACEMENT

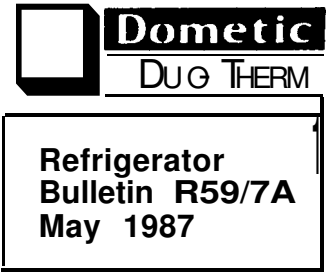

NOTE: Please **take** full consideration of the following information **BEFORE** replacing module boards due to faulty 12 volt cooling operation.

This Bulletin clarifies the 12 volt DC start-up and cooling operation.

Each time the tag line is energized and 12 volt cooling is selected, the module board must receive approximately 13.6 volts for about 40 or more seconds. At that time the unit will engage the 12 volt heating element. If the initial required 13.6 volts is not achieved (due to demands of other 12 volt devices) the AES will not switch to 12 volt operation, and will operate instead on L.P. gas until the 13.6 volt threshold is reached.

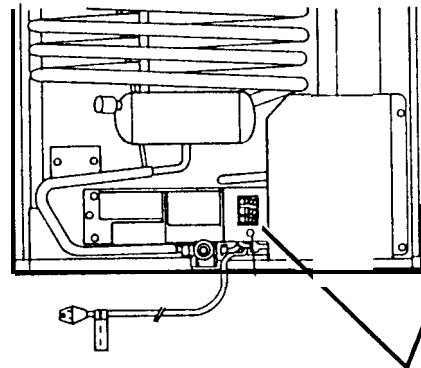
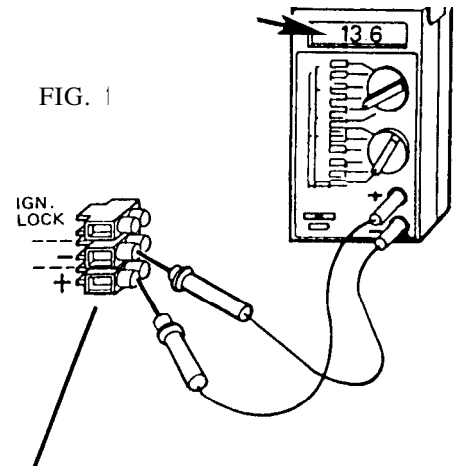
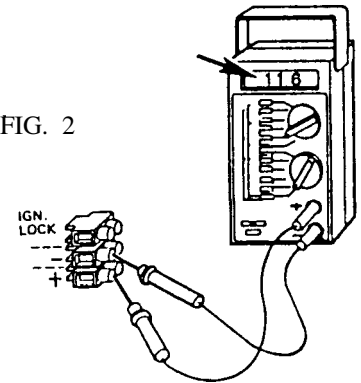



FIG. 1



If during 12 volt cooling, supply voltage should drop below approximately 11.6 volts (FIG. 2), the DC cooling will shut down and the AES system will go into a 25 minute delay (FIG. 3). This allows the supply voltage to re-establish itself.

FIG. 2



To view the delay, push the button identified with a question mark  and the clock indicator  will come on.

NOTE: If 13.6 volts is not recovered during the delay the AES system will then switch to gas operation until the supply voltage recovers. If during the 25 minute delay the 13.6 threshold voltage is recovered, the delay will be deleted and 12 volts DC cooling will resume.



AES CONTROL PANEL ON REFRIGERATOR

FIG. 3

As with all AES refrigerators, minimum voltage for any operation is 10.5 volts DC at the terminal block.

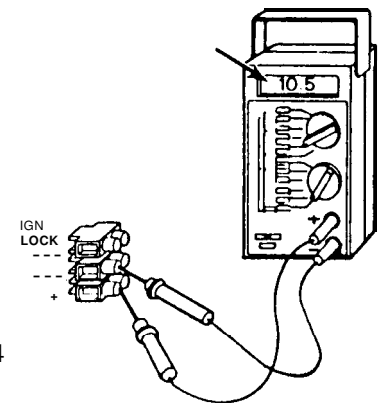

FIG. 4



(PRE- DELIVERY INSPECTION)

REFRIGERATOR
BULLETIN R60/7A
SEPT. 1987

PDI insures safe operation of Dometic Refrigerators. The following checks on each unit are advised before being operated by the consumer. If each refrigerator is inspected according to these guidelines, you can be assured of peak performance from your Dometic refrigerator.

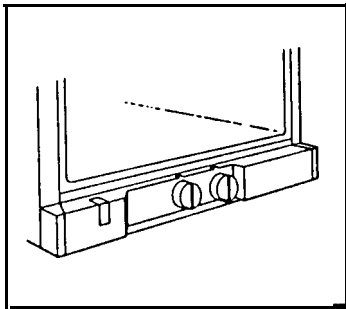

3-Way
RM1303

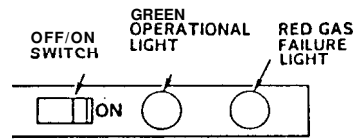

RM3500
RM3600
RM3800



3-Way

RM3501
RM3601
RM3801



2-Way

RM2602
RM2802



AES PRE-DELIVERY CHECK FOR MODEL RM1303 AES REFRIGERATOR

This refrigerator is equipped with an Automatic Energy Selector System. The selection will be made with the highest priority to 120 volts; second priority to 12 volts from the battery if the ignition is turned on; and with the lowest priority to gas operation.

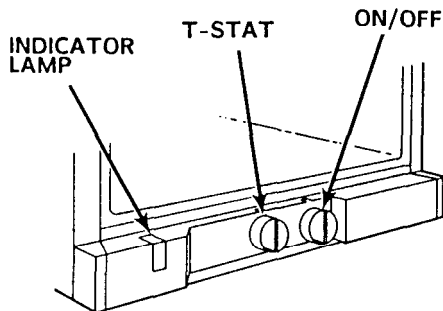

OPERATIONAL TESTS

- A. Have 120 volt supply available
- B. Make sure you have a good 12 volt battery supply.
- C. Make sure gas valves at tank and rear of refrigerator have been turned on.
- D. Turn ON/OFF switch to ON (bottom right front of refrigerator).
- E. Set thermostat to setting above #4 (second knob from right).
- F. Connect 120 volt supply. Green indicator light should be on.
- G. Check boiler box to see if it is warming up.

CAUTION: This area becomes extremely hot and can **cause burns**.

- H. Disconnect the 120 volt supply at rear of refrigerator compartment. The AES unit should go to gas operation. Check burner box to see if flame is lit.

- I. Supply 12 volts to ignition lock terminal at rear of refrigerator, or start engine. Flame should go out

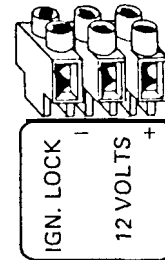

- J. Remove 12 volt from ignition position. The unit should now be in a gas delay. This delay should be approximately 20 minutes.
- K OVER-RIDE DELAY
 1. Turn ON/OFF switch from ON to OFF, wait approximately 5 seconds and turn back ON.
 2. The burner should re-light in approximately 15 seconds.

- L. If the above tests are performed without fault, the AES is operating properly.

NOTE: FLASHING RED LIGHT: This indicates the unit tried to light on gas and failed. It is possible the unit had air in the lines. Reset the controls.

Make sure the AES is wired directly to battery with 30 amp breaker within 18 inches of battery.

AES

PRE-DELIVERY CHECK FOR MODEL RM3500, RM3600, RM3800

NOTE: The above model numbers are upgraded versions of the AES system.

Normal operation will be the same as first generation. The units will have the following changes: Switch, Thermostat and Light.

4. The refrigerator is equipped with a thermostat which is located inside the cabinet on the front of the light fixture.

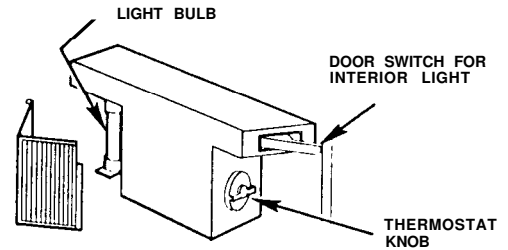
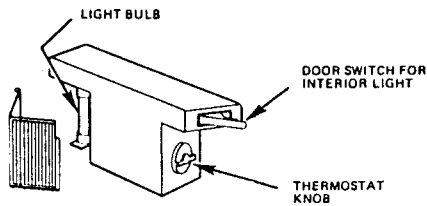

1. The ON/OFF switch is located at the top right side of the refrigerator.
2. The first light to the right of the ON/OFF switch is the green light. When the ON/OFF switch is in the ON position, this light will be green.
3. The second light to the right of the ON/OFF switch is the FLAME FAILURE light. This will flash if the unit fails to light on gas.

5. This is regulated by turning the knob to different settings in order to obtain desired cabinet temperatures. The closer the knob is set to maximum, the lower the temperature.

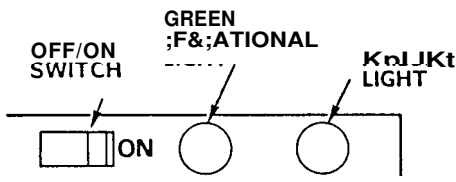

AES

PRE-DELIVERY CHECK FOR MODELS RM3601 AND RM3801

1. The AES automatically selects the best energy source for the situation, either 120 volts, 12 volts or LP gas.
2. This unit will also let you select the energy source you want.
3. Pictured below is the AES control panel that is found on this generation of AES refrigerators.

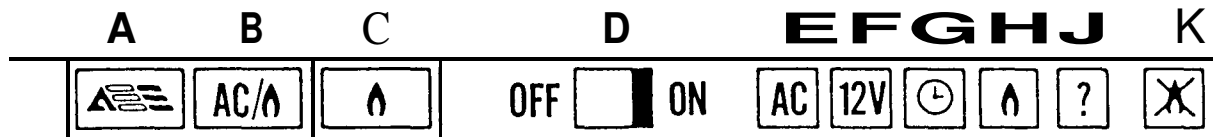

AES CONTROL PANEL ON REFRIGERATOR

- A. Push button, green indicator - Full AES operation.
- B. Push button, green indicator - Limited AES operation:
120 volts or LP gas (priority to 120 volts).
- C. Push button, green indicator - LP gas operation only.
- D. Main switch - Push right, to turn unit ON. Push left to turn unit OFF.
- E. Yellow indicator - 120 volt operation mode.
- F. Yellow indicator - 12 volt operation mode.
- G. Yellow indicator - LP gas delay mode.
- H. Yellow indicator - LP gas operation.
- I. Question mark - push button. When pushed this button will indicate which mode is in operation, E-F-G or H.
- J. Flame Failure indicator - Indicates unit tried to light on LP gas and failed.

OPERATIONAL TEST

1. Make sure you have a good 120 volt supply available.
2. You must also have a good 12 volt supply.
3. Be sure all LP gas valves have been turned on, those at LP tanks and at rear of refrigerator.
4. Turn ON/OFF switch 'D' to the ON position.
5. Connect 120 volt supply to unit.
6. When switch 'D' is set to ON, the AES button will light up (green), indicating that the control system is in the automatic mode. In this mode 120 volts A/C has priority.
7. Push the question mark button 'J'. Now yellow indicator 'E' (A/C) should light up.

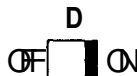

9. When switch "B" is pushed, the control system will select only between 120 volts A/C and LP gas operation. To check, push question mark button "J". Indicator light "E" should light up.



10. To check gas operation of switch "B", remove 120 volt supply from rear of refrigerator. Push switch "J" (question mark). Flame indicator should light.

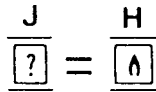

11. When switch "C" is pushed the refrigerator will operate only on LP gas, even if 120 volt A/C or 12 volt DC is available.

To check gas operation of switch "C": Push question mark "J". Flame indicator light "H" should now light.



12. Indicator "K" flame failure. This indicator will light only when there has been a flame failure in the LP gas operation mode. To restart gas operation, set switch "D" to OFF.

Wait 5 seconds, then switch back to ON. Flame failure indicator will go off, and system will start another cycle for ignition.



13. Indicator "G". This light will come on when engine is turned off. The AES system goes into a delay cycle which prevents LP gas operation for 25 minutes. This is a refueling precaution. If the engine is started during the delay cycle, 12 volts will resume and the delay period will be reset to 25 minutes. This means every time the engine is turned off, you will have a complete 25 minute delay.



NOTE: Each time tag line is energized and 12 volt cooling is selected, the module board must receive approximately 13.6 volts for 40 or more seconds. At that time the unit will engage the 12 volt heating element. If initial 13.6 volts is not achieved (due to demands of other 12 volt devices in the vehicle), the AES will not switch to 12 volt operation and will operate instead on gas until the 13.6 volt threshold is achieved.

As with all AES refrigerators, minimum voltage for any operation is 10.5 volts DC at the terminal block.

FREEDOM SERIES

RM 2602 AND RM2802 2-WAY

(PDI) PRE-DELIVERY INSPECTION

PDI insures safe operation of Dometic refrigerators. The following checks on each unit are advised before being operated by the consumer. If each refrigerator is inspected according to these guidelines, you can be assured of peak performance from your Dometic refrigerator.

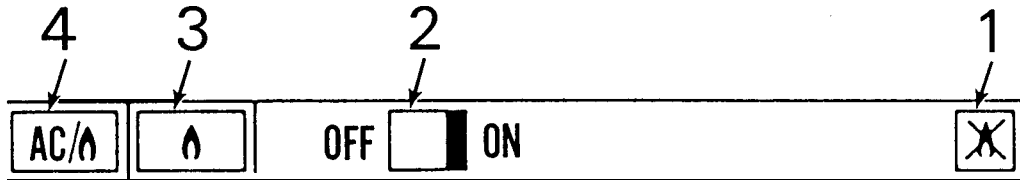

1. ORANGE continuous light: Indicates gas ignition failure - no gas.
2. MAIN SWITCH
3. PUSH BUTTON: Green - indicates gas operation ONLY.
4. PUSH BUTTON: Green - Gives energy selection between A/C and Gas.

NOTE: No 12 volt power selection possible.

OPERATIONAL TEST

- A. Have 120 volt A/C supply available.
- B. Be sure you have a good 12 volt battery supply.
- C. Make sure gas valves, both at tank and rear of refrigerator, have been turned on.
- D. Turn ON/OFF switch to "ON" position.
- E. Set thermostat to "NORMAL" position.
 1. Plug coach 120 volt cord into 120 volt outlet.
 2. Green A/C flame light #4 should be on.



3. Disconnect 120 volt cord. The refrigerator should now light on gas. If this is not accomplished in approximately 3 minutes, the Flame Failure Light will come on.



To correct this turn main switch OFF and the back to ON. The green A/C flame light should come on again.

4. To check GAS ONLY operation, push #3, Green Flame Light. The system will then operate on gas regardless if 120 volt power is present. If unit fails to light, Flame Failure Light will come on. Turn OFF main switch and then turn back to ON. Unit should now be lit on GAS.



GENERAL INFORMATION FOR MODELS RM2602 & RM2802

The refrigerator is equipped with an energy selector system. The system selects the most suitable available energy source. The selection will be made with the highest priority to 120 volts and the lowest priority to gas operation.

If the gas mode is chosen, the unit will operate on gas only, even if 120 volts are present.

The control system always requires 12 volts DC to be able to operate on ANY energy mode. Below 9.5 volts DC the control system will go to gas with no thermostat control.

Once the low voltage has been corrected, the control system goes back to normal operation. To indicate that the control system is in a low DC voltage condition the selector mode

[A/C GAS] indicator will be turned off. The interior light is unaffected during the entire procedure.

If the refrigerator does not succeed in lighting on gas the first time, turn unit OFF and then ON since there might be air in the lines.

AES REFRIGERATOR DIAGNOSTIC SERVICE MANUAL OS1160-A



<u>Page</u>	<u>Description</u>
A-1	Title Page
A-2	Notes
A-3	Table of Contents
A-4	Notes
A-5-1	AES Refrigerator Diagnostic Flow Chart / No Operation
A-5-2	AES Refrigerator Diagnostic Flow Chart / No 120V AC Operation
A-5-3	AES Refrigerator Diagnostic Flow Chart / No 12V DC Operation (Checks AES Mode Only)
A-5-4	AES Refrigerator Diagnostic Flow Chart / No Gas Operation
A-5-5	AES Refrigerator Diagnostic Flow Chart / No Gas Operation (continued)
A-6-1	Operation and Diagnosis - Dometic AES Refrigerator
A-6-2	Operation and Diagnosis - Dometic AES Refrigerator (continued)
A-6-3	Operation and Diagnosis - Dometic AES Refrigerator (continued)
A-6-4	Operation and Diagnosis - Dometic AES Refrigerator (continued)
A-6-5	Operation and Diagnosis - Dometic AES Refrigerator (continued)
A-6-6	Operation and Diagnosis - Dometic AES Refrigerator (continued)
A-6-7	Operation and Diagnosis - Dometic AES Refrigerator (continued)
A-6-8	Operation and Diagnosis - Dometic AES Refrigerator (continued)
A-6-9	Operation and Diagnosis - Dometic AES Refrigerator (continued)
A-6-10	Operation and Diagnosis - Dometic AES Refrigerator (continued)
A-6-11	Operation and Diagnosis - Dometic AES Refrigerator (continued)
A-6-12	Operation and Diagnosis - Dometic AES Refrigerator (continued)
A-6-13	Operation and Diagnosis - Dometic AES Refrigerator (continued)
A-6-14	Operation and Diagnosis - Dometic AES Refrigerator (continued)
A-6-15	Operation and Diagnosis - Dometic AES Refrigerator (continued)
A-6-16	Operation and Diagnosis - Dometic AES Refrigerator (continued)
A-6-17	Operation and Diagnosis - Dometic AES Refrigerator (continued)
A-6-18	Operation and Diagnosis - Dometic AES Refrigerator (continued)
A-6-19	Operation and Diagnosis - Dometic AES Refrigerator (continued)
A-6-20	Operation and Diagnosis - Dometic AES Refrigerator (continued)
A-6-21	Operation and Diagnosis - Dometic AES Refrigerator (continued)
A-6-22	Operation and Diagnosis - Dometic AES Refrigerator (continued)
A-6-23	Operation and Diagnosis - Dometic AES Refrigerator (continued)
A-6-24	Operation and Diagnosis - Dometic AES Refrigerator (continued)
A-6-25	Operation and Diagnosis - Dometic AES Refrigerator (continued)
A-6-26	Operation and Diagnosis - Dometic AES Refrigerator (continued)
A-6-27	Operation and Diagnosis - Dometic AES Refrigerator (continued)
A-6-28	Operation and Diagnosis - Dometic AES Refrigerator (continued)
A-6-29	Operation and Diagnosis - Dometic AES Refrigerator (continued)
A-6-30	Operation and Diagnosis - Dometic AES Refrigerator (continued)
A-6-31	Operation and Diagnosis - Dometic AES Refrigerator (continued)
A-6-32	Operation and Diagnosis - Dometic AES Refrigerator (continued)
A-6-33	Operation and Diagnosis - Dometic AES Refrigerator (continued)
A-6-34	Operation and Diagnosis - Dometic AES Refrigerator (continued)
A-6-35	Operation and Diagnosis - Dometic AES Refrigerator (continued)
A-6-36	Operation and Diagnosis - Dometic AES Refrigerator (continued)
A-6-37	Operation and Diagnosis - Dometic AES Refrigerator (continued)
A-6-38	Operation and Diagnosis - Dometic AES Refrigerator (continued)
A-6-39	Operation and Diagnosis - Dometic AES Refrigerator (continued)
A-6-40	Operation and Diagnosis - Dometic AES Refrigerator (continued)
A-6-41	Operation and Diagnosis - Dometic AES Refrigerator (continued)
A-6-42	Operation and Diagnosis - Dometic AES Refrigerator (continued)
A-6-43	Operation and Diagnosis - Dometic AES Refrigerator (continued)
A-6-44	Operation and Diagnosis - Dometic AES Refrigerator (continued)
A-6-45	Operation and Diagnosis - Dometic AES Refrigerator (continued)
A-6-46	Operation and Diagnosis - Dometic AES Refrigerator (continued)

<u>Page</u>	<u>Description</u>
A-6-47	Operation and Diagnosis - Dometic AES Refrigerator (continued)
A-6-48	Operation and Diagnosis - Dometic AES Refrigerator (continued)
A-6-49	Operation and Diagnosis - Dometic AES Refrigerator (continued)
A-7-1	AES Refrigerator Glossary of Terms
A-7-2	AES Refrigerator Glossary of Terms (continued)
A-7-3	AES Refrigerator Glossary of Terms (continued)
A-7-4	AES Refrigerator Glossary of Terms (continued)
A-7-5	AES Refrigerator Glossary of Terms (continued)
A-7-6	AES Refrigerator Glossary of Terms (continued)
A-7-7	AES Refrigerator Glossary of Terms (continued)
A-8-1	3801 AES Refrigerator Continuity Readings for Switch Card & Harness
A-8-2	3801 AES Refrigerator Continuity Readings for Switch Card & Harness (continued)
A-8-3	3801 AES Refrigerator Continuity Readings for Switch Card & Harness (continued)
A-8-4	2802 AES Refrigerator Continuity Readings for Switch Card & Harness
A-8-5	2802 AES Refrigerator Continuity Readings for Switch Card & Harness (continued)
A-9-1	Bulletin #46 Operation of AES System
A-9-2	Bulletin #46 (continued)
A-9-3	Bulletin #46 (continued)
A-9-4	Bulletin #46 (continued)
A-9-5	Bulletin #46 (continued)
A-10-1	AES Refrigerator Wiring Diagram RM663 & RM763
A-10-2	AES Refrigerator Wiring Diagram RM1303 & RM3500, 3600 & RM3800
A-11-1	Bulletin #51 Circuit Board Diagnosis
A-11-2	Bulletin #53 Automatic Energy Selector
A-11-3	Bulletin R56/7A Replacement of Circuit Board
A-11-4	Bulletin R56/7A (continued)
A-11-5	Bulletin R56/7A (continued)
A-11-6	Bulletin R58/7A Replacement of Circuit Board RM663, RM763, RM1303
A-11-7	Bulletin R58/7A (continued)
A-11-8	Bulletin R58/7A (continued)
A-11-9	Bulletin R59/7A AES Models 3601-3801 Module Board Replacement
A-11-10	Bulletin R60/7A AES PDI
A-11-11	Bulletin R60/7A (continued)
A-11-12	Bulletin R60/7A (continued)
A-11-13	Bulletin R60/7A (continued)
A-11-14	Bulletin R60/7A (continued)
A-11-15	Bulletin R60/7A (continued)
A-12	General Information for Models RM2602 & RM2802
A-13	Notes
A-14	AES Refrigerator Diagnostic Service Subscription Order Form
A-15	Blank



Manual provided courtesy
Bryant RV Services
www.byantrv.com

All manuals are believed to be released for distribution, and/or in the public domain.

Service manuals provided with the understanding that persons using them are well versed in proper safety practices, and are familiar with basic safety procedures, including, but not limited to safety procedures dealing with 120 volt electricity, high amperage 12 volt circuits an LPG (propane) systems.

If in doubt, consult a professional (better safe than sorry).